

SANTA FE

To access the **online manual** for Car Infotainment System,
scan the **QR code**.



- This guide covers specifications for all vehicle models, including optional specifications, and is based on the latest version of system software.
- The design and specification of the system may change without prior notice for performance improvement.
- In order to improve the product performance, the functions and services in this manual are subject to change without notice. In case of software update, the screens in this manual may differ from actual ones on the product.
- For more information about the functions and services updated for performance improvement, access the online user's manual.
- Functions and services in this manual may differ from those in the actual vehicle. For more details, refer to the owner's manual or brochure of your vehicle.
- Your system is not compatible with the system software and map data for regions outside of the country of purchase.

Be sure to read this User's Manual before using the product to ensure safety and usability.

Reading the manual on web with the QR code

You can access the online user's manual of the system by scanning the QR code with your smartphone.

Warning

Park the vehicle at a safe place and scan the QR code. To ensure your safety, the system does not provide QR codes while driving.

1 Scan the QR code by using any of the following methods:

- On the All Menu screen, press **User's Manual**.
- On the All Menu screen, press **Setup ▶ General ▶ System Info ▶ User's Manual on Web (QR Code)**.
- Or scan the QR code in the Quick Reference Guide.

2 Scan the QR code after installing the QR code reader App from App Store or Google Play Store .



3 Press the URL for User's Manual on Web from the smartphone display.

The online user's manual of the system appears in the Internet browser App on the smartphone.

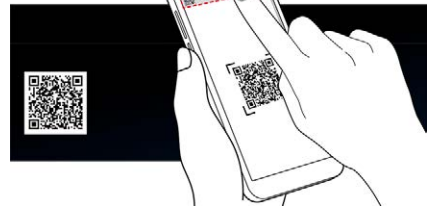

- ✍ Depending on how you scan the QR code, the online manual may open without pressing the URL.
- ✍ With a camera App of your iPhone or Android smartphone, the QR code can also be scanned. Depending on the Android smartphone model, the QR code scanning may not be supported for the provided App. For more details, see the smartphone's manual.
- ✍ When you scan the QR code on each function menu, you can see the usage of the function running (except for several functions).
 - Run the desired function on the system and then press **User's Manual on Web (QR Code)** from the menus on the screen.
- ✍ Without scanning the QR code, you can directly enter the URL address to see User's Manual on Web. (http://webmanual.hyundai.com/STD_GEN5_WIDE/AVNT/CAN/English/index.html)

Safety Warnings

Be sure to keep the following instructions. Otherwise, it may cause serious injury or accident.

Driving

Obey all traffic laws while driving.

- Relying solely on the navigation system may cause violation of traffic rules and regulations, resulting in an accident.

In order to check the vehicle speed, see the speedometer first, not the speed on the navigation system.

- The speed on the navigation system may differ from actual vehicle speed.

While driving, refrain from watching the screen.

- An accident may occur by negligence in keeping your eyes forward.
- To manipulate the screen or buttons requiring multiple steps, be sure to stop your vehicle.

To use your mobile phone, first stop your vehicle.

- When you use your mobile phone while driving, it may disperse your attention, resulting in an accident.
- When making a call while driving, use the Bluetooth Hands-free function and if possible, minimize the call time.

Make sure that the volume of the phone is sufficiently low so that the external sound is audible.

- When you drive with no external sound present may cause a traffic accident.
- When you drive for a long time with a loud audio volume, it may affect your hearing.

For emergency services (e.g. hospital, fire station), do not rely solely on the navigation system.

- Some emergency services may not be included in the navigation map. Check relevant information in advance to stay prepared for an emergency.

System handling

Do NOT arbitrarily disassemble or modify the system.

- It may cause an accident, fire, or electric shock.

Exercise caution to make sure that no liquid or foreign materials enter the system.

- It may cause smoke generation, fire ignition, or system failure.

When the screen is not displayed, the volume is muted, or other system failures occur, immediately stop using the system.

- Otherwise, it may cause fire, electric shock, or fatal system failure.

 If you experience any problems with the system, contact your place of purchase or dealer.

Safety Precautions

Be sure to keep the following instructions. Otherwise, it may cause minor injury or system damage.

Operation

Use the system with the vehicle started.

- When you use the system for a long time with the vehicle stopped, it may cause battery discharge.

Do NOT arbitrarily install an unauthorized aftermarket product in your vehicle.

- Using unapproved products may cause an error while using the system.
- System errors caused by installing unapproved products are not covered under the warranty.

System handling

Do NOT apply excessive force to the system.

- When you apply excessive pressure to the screen, the LCD panel or touch panel may get damaged.

To clean the screen or button panel, first turn off the vehicle and then use a dry, soft cloth to wipe it.

- Do not wipe using a rough or hard cloth, chemical fiber, organic solvent (e.g. alcohol, benzene, thinner), or air freshener. The panel surface may become scratched or damaged due to a chemical reaction.

When you install an air freshener on the air conditioner vent, the surface may be deformed due to leakage.

 If you experience any problems with the system, contact your place of purchase or dealer.

Component names and functions

Control panel

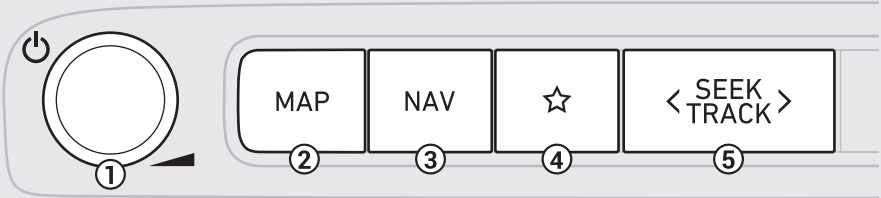

① POWER button/VOLUME knob

- Turn on or off the Radio/Media.
- Press and hold the button to turn off the screen and sound.
- Turn the knob to adjust the system volume (except for navigation sound).

② MAP button

- Returns to the current location on the map.
- While in guidance on the navigation screen, press to repeat the voice guidance.

③ NAV button

- Displays the Navigation Menu screen.
- Press and hold the button to display the Places screen.

④ Custom button

- Runs the user-defined function.
- Press and hold the button to display the function settings screen.

⑤ SEEK/TRACK button

- While listening to the radio, change the station.
- While playing media, change the track/file. Press and hold to rewind or fast forward (except for the Bluetooth audio mode).

 The system shape and menu arrangement may differ depending on the vehicle model and specifications.

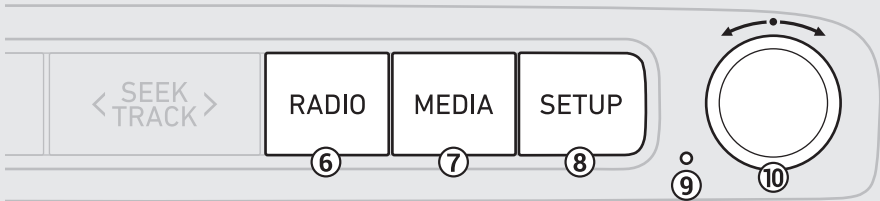

⑥ RADIO button

- Turns on the radio.
- When the radio is on, press the button repeatedly to toggle between FM, AM and SiriusXM modes.

⑦ MEDIA button

- Runs the connected media.
- Press and hold the button to display the Radio/Media selection window.

⑧ SETUP button

- Displays the Settings screen.
- Press and hold the button to display the version information screen.

⑨ System Reset button

- Restarts the system.

⑩ Search knob

- While listening to the radio, adjust the frequency or change the broadcasting channel.
- While playing media, scan music or files.
- During scanning, select the current channel, music or file.
- On the map screen, zoom in or out on the map (if activated).

Steering wheel remote control

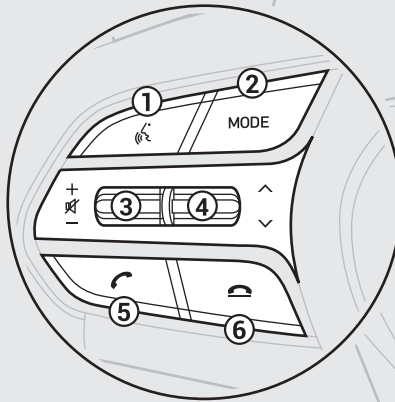

① Voice Recognition button

- Press to start voice recognition.
- Press and hold to start voice recognition of a connected smartphone via phone projection. (The button's operation may vary depending on smartphone specifications.)

② MODE button

- Press the button repeatedly to change the system mode (radio, media, etc.).
- Press and hold the button to display the function settings screen.

③ Volume lever/button

- Adjust the volume.
- Press the button to mute or unmute the volume (except for navigation sound).
- Press the button to pause or resume playback.

④ Move lever

- While listening to the radio, switch between the stations on the preset list. Press and hold to search for a station.
- While playing media, change the track/file. Press and hold to rewind or fast forward (except for the Bluetooth audio mode).

⑤ Call button

- Before connection of Bluetooth: Press to display the Bluetooth connection window.
- After connection of Bluetooth: Press to display the recent calls list. To redial the last call number, press and hold the button. When a call comes in, press to answer the call.
- During a Bluetooth call: Press to switch to Call Waiting. Press and hold to switch between the system and mobile phone.

⑥ End Call button

- After connection of Bluetooth: When a call comes in, press to reject the call.
- During a Bluetooth call: Press to end a call.

🔗 The system shape and menu arrangement may differ depending on the vehicle model and specifications.

Turning on/off the system

Turning on the system

- 1 Turn on the vehicle.
- 2 When a safety warning message appears, read it and press **Confirm**.
 - ✍ To change the display language, press **Language**.

Turning off the system

To turn off the system while driving, press and hold the Power button on the panel.

The screen and sound will be turned off.

- ✍ To use the system again, press the Power button.
- ✍ When a specified period of time elapses after turning off the vehicle, the system automatically shuts down. When you open the driver's door, the system immediately shuts down.

Warning

- Driving while distracted can result in a loss of vehicle control that may lead to an accident, severe bodily injury, or death. The driver's primary responsibility is the safe and legal operation of the vehicle, and the use of any vehicle systems, including the touch screen and steering wheel controls, which take the driver's eyes, attention, and focus away from the safe operation of the vehicle, or which are not permissible by law, should never be used during the operation of the vehicle.
- Some functions may not be active while driving to ensure safety. Those functions run only when the vehicle is stationary. In order to use them, first stop the vehicle.
- When the screen is not displayed, the volume is muted, or other system failures occur, immediately stop using the system. When you use the faulty system continuously, it may cause fire, electric shock, or fatal system failure.

Caution

- The system can be turned on even when the ignition switch is in "ACC" or "ON." However, when you use the system without turning on the vehicle for a long time, it may cause battery discharge. To use the system for a long time, be sure to turn on the vehicle.
- When you use the system with the vehicle turned off, the battery warning message appears. The warning message disappears as soon as you turn on the vehicle.

How to Update the Map and Software for your Infotainment System

To ensure you are maximizing the full potential of your navigation system, we advise updating the map and software annually. To update, visit the map update website and install the Navigation Updater program onto your PC. Use the program to download and install the latest map, points of interest, and software. Alternatively, you can visit your local dealership to update.

Product specifications

Common specifications

Item	Specifications
External dimensions	297.5 x 158.8 x 239.45 mm
Weight	2.05 kg

Display

Item	Specifications
Display size	AV body - 10.25 inch (243.65 x 91.37 mm)
Number of pixels	AV body - 1,382,400 pixels (resolution: 1920 x 720)
Drive system	TFT (Thin Film Transistor) active matrix system
Viewing angle	AV body - Left/right, Horizontal/vertical: 89°
Internal lighting	LED

ISED

This device contains license-exempt transmitter(s)/receiver(s) that comply with Innovation, Science and Economic Development Canada's license-exempt RSS(s). Operation is subject to the following two conditions:

1. This device may not cause interference.
2. This device must accept any interference, including interference that may cause undesired operation of the device.

This equipment complies with ISED radiation exposure limits set forth for an uncontrolled environment.

This equipment should be installed and operated with minimum 20 cm between the radiator and your body.

This transmitter must not be co-located or operating in conjunction with any other antenna or transmitter unless authorized to do so by the ISED.

L'émetteur/récepteur exempt de licence contenu dans le présent appareil est conforme aux CNR d'Innovation, Sciences et Développement économique Canada applicables aux appareils radio exempts de licence. L'exploitation est autorisée aux deux conditions suivantes :

1. L'appareil ne doit pas produire de brouillage;
2. L'appareil doit accepter tout brouillage radioélectrique subi, même si le brouillage est susceptible d'en compromettre le fonctionnement.

Cet appareil est conforme aux limites d'exposition aux rayonnements de l'ISDE pour un environnement non contrôlé.

L'antenne doit être installée de façon à garder une distance minimale de 20 centimètres entre la source de rayonnements et votre corps.

L'émetteur ne doit pas être colocalisé ni fonctionner conjointement avec à autre antenne ou autre émetteur, à moins d'y être autorisé par l'ISDE.

MEMO

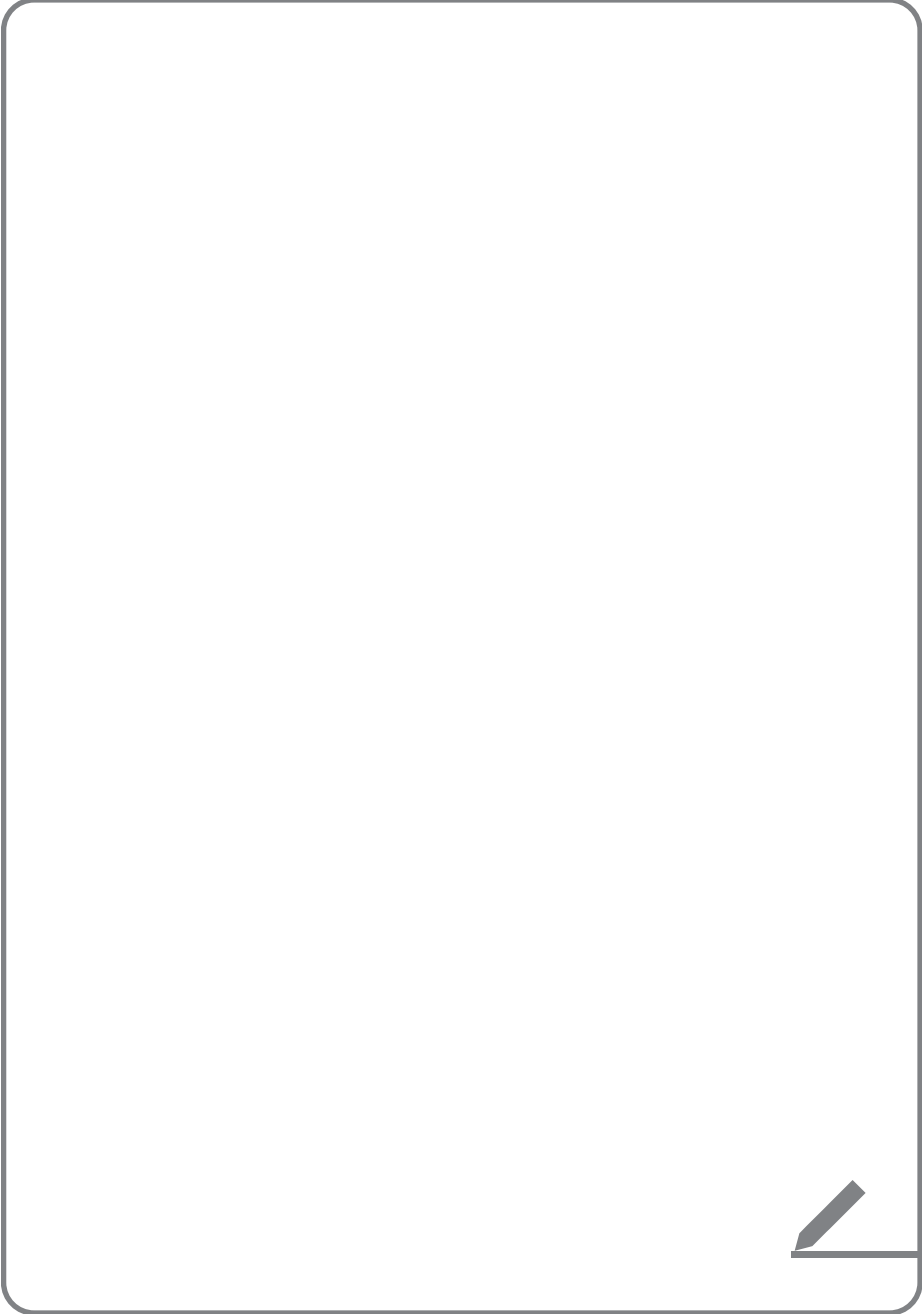

Car Infotainment System

User's Manual

- This guide covers specifications for all vehicle models, including optional specifications, and is based on the latest version of system software.
- The design and specification of the system may change without prior notice for performance improvement.
- In order to improve the product performance, the functions and services in this manual are subject to change without notice. In case of software update, the screens in this manual may differ from actual ones on the product.
- For more information about the functions and services updated for performance improvement, access the online user's manual.
- Functions and services in this manual may differ from those in the actual vehicle. For more details, refer to the owner's manual or brochure of your vehicle.
- Your system is not compatible with the system software and map data for regions outside of the country of purchase.

Available materials for operation



Quick Reference Guide

Provided in the format of a booklet. It provides brief information of the system, including basic controls and main functions.



User's Manual on Web

To view related information while using the system, press **User's Manual on Web (QR Code)** from the menus on the screen. By scanning the QR code with your smartphone, you can access the online user's manual.

Symbols in this User's Manual



Warning

Indicates very important information directly related to user safety. Failure to follow instructions may cause serious injury.



Caution

Indicates important information directly related to user safety. Failure to follow instructions may cause minor injury or vehicle damage or breakdown.



Note

Indicates helpful information for operation of the product.

If equipped

Indicates descriptions for optional features, which may not be available on your specific vehicle depending on the model or trim level.

This guide covers specifications for all vehicle models, including optional specifications. It may include descriptions for features that are not equipped in your vehicle or are unavailable for your vehicle model.

HEV only

Displays only the functions that can be used in a hybrid vehicle.

PHEV only

Displays only the functions that can be used in a plug-in hybrid vehicle.

EV only

Displays only the functions that can be used in an electric vehicle.

Safety Warnings

Be sure to keep the following instructions. Otherwise, it may cause serious injury or accident.



Driving

Obey all traffic laws while driving.

- Relying solely on the navigation system may cause violation of traffic rules and regulations, resulting in an accident.

In order to check the vehicle speed, see the speedometer first, not the speed on the navigation system.

- The speed on the navigation system may differ from actual vehicle speed.

While driving, refrain from watching the screen.

- An accident may occur by negligence in keeping your eyes forward.
- To manipulate the screen or buttons requiring multiple steps, be sure to stop your vehicle.

To use your mobile phone, first stop your vehicle.

- When you use your mobile phone while driving, it may disperse your attention, resulting in an accident.
- If necessary, use handsfree (Bluetooth) calling when driving and minimize the call time.

Make sure that the volume of the phone is sufficiently low so that the external sound is audible.

- When you drive with no external sound present may cause a traffic accident.
- When you drive for a long time with a loud audio volume, it may affect your hearing.

For emergency services (e.g. hospital, fire station), do not rely solely on the navigation system.

- Some emergency services may not be included in the navigation map. Check relevant information in advance to stay prepared for an emergency.



System handling

Do NOT arbitrarily disassemble or modify the system.

- It may cause an accident, fire, or electric shock.

Exercise caution to make sure that no liquid or foreign materials enter the system.

- It may cause smoke generation, fire ignition, or system failure.

When the screen is not displayed, the volume is muted, or other system failures occur, immediately stop using the system.

- Otherwise, it may cause fire, electric shock, or fatal system failure.

 If you experience any problems with the system, contact your place of purchase or dealer.

Safety Precautions

Be sure to keep the following instructions. Otherwise, it may cause minor injury or system damage.

Operation

Use the system with the vehicle started.

- When you use the system for a long time with the vehicle stopped, it may cause battery discharge.

Do NOT arbitrarily install an unauthorized aftermarket product in your vehicle.

- Using unapproved products may cause an error while using the system.
- System errors caused by installing unapproved products are not covered under the warranty.

System handling

Do NOT apply excessive force to the system.

- When you apply excessive pressure to the screen, the LCD panel or touch panel may get damaged.

To clean the screen or button panel, first turn off the vehicle and then use a dry, soft cloth to wipe it.

- Do not wipe using a rough or hard cloth, chemical fiber, organic solvent (e.g. alcohol, benzene, thinner), or air freshener. The panel surface may become scratched or damaged due to a chemical reaction.

When you install an air freshener on the air conditioner vent, the surface may be deformed due to leakage.

 If you experience any problems with the system, contact your place of purchase or dealer.

Contents

01 System overview

Component names and functions	1-2
Turning on/off the system	1-6
Using the touch screen	1-8
Using the Home screen	1-11
Accessing the All Menus screen	1-15
Using the split screen	1-16

02 Useful functions

Using the First Run Setup	2-2
Using the phone projection function	2-4
Viewing the driving assistance screen	2-9
Using the climate control function	2-14
Using the rear-seat climate control function	2-18
Using the rear-seat conversation mode	2-20
Using the rear-seat quiet mode	2-21
Playing Sounds of Nature	2-22
Using the HD Radio™ Data	2-23
Viewing the driving information	2-26
Viewing notifications	2-27
Using the Valet mode	2-28
Using N mode	2-29

03

Radio

Turning on the radio	3-2
Listening to HD Radio™	3-11
Listening to SiriusXM™ radio	3-13

04

Media

Using media	4-2
-------------	-----

05

Navigation

Navigation functions	5-2
Various ways to find routes	5-10
Using saved favorite places	5-22
Viewing traffic Information	5-26
Searching for gas stations	5-28
Searching for EV (Electric Vehicle) charging stations	5-29
END USER LICENSE AGREEMENT	5-30

06

Phone

Connecting a Bluetooth device	6-2
Making a call via Bluetooth	6-6
Accepting an incoming call over Bluetooth	6-15
Checking new messages over Bluetooth	6-17

07 Voice functions

Voice recognition	7-2
Using the Siri Eyes Free	7-21
Voice Memo	7-22

08 Bluelink

Bluelink service	8-2
Running the Bluelink menu	8-4
Using safety and security services	8-11
Route guidance service	8-12
Duties Upon Sale or Transfer of Vehicle	8-14

09 Settings

Configuring system settings	9-2
Configuring the vehicle settings (Type1)	9-3
Configuring the vehicle settings (Type2)	9-20
Configuring the device connections settings (Type1)	9-40
Configuring the device connections settings (Type2)	9-44
Configuring the advanced system settings (Type1)	9-49
Configuring the button settings (Type1)	9-53
Configuring the button settings (Type2)	9-54

Configuring the sound settings (Type1)	9-58
Configuring the sound settings (Type2)	9-62
Configuring the voice recognition settings (Type1)	9-67
Configuring the voice recognition settings (Type2)	9-68
Configuring the navigation settings (Type1)	9-69
Configuring the navigation settings (Type2)	9-74
Configuring the Bluelink settings (Type1)	9-81
Configuring the Bluelink settings (Type2)	9-82
Configuring the user profile settings (Type1)	9-83
Configuring the user profile settings (Type2)	9-84
Configuring the general system settings (Type1)	9-86
Configuring the general system settings (Type2)	9-92
Configuring the screen layout settings (Type2)	9-98
Configuring the display settings (Type1)	9-99
Configuring the display settings (Type2)	9-104
Configuring the media settings (Type1)	9-109
How to Update the Map and Software for your Infotainment System	9-110

10

Appendix

Solutions	10-2
System status indicator icons	10-9
FAQ	10-11
Product specifications	10-13
Important information	10-17
Index	10-19
Trademarks	10-23
Open Source Information	10-24

MEMO

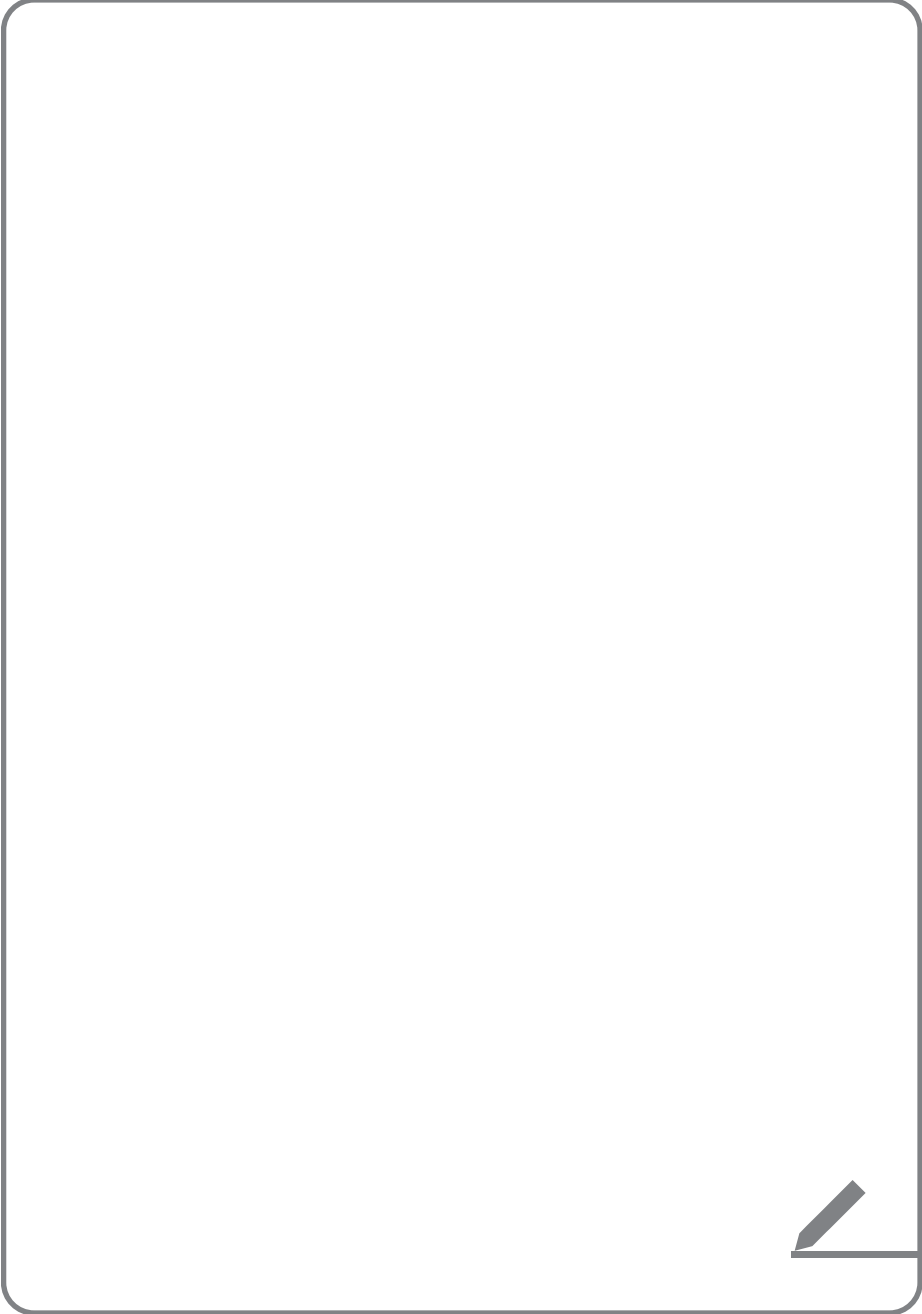

01

System overview

Component names and functions

Turning on/off the system

Using the touch screen

Using the Home screen

Accessing the All Menus screen

Using the split screen



Component names and functions

The following describes the part names and controls on the control panel and steering wheel.

Control panel

 The shape may differ depending on the vehicle model and specifications. For more information, see "Quick Reference Guide" that is separately provided.

Option A

POWER button
(POWER/PWR)/
VOLUME knob
(VOLUME/VOL)
(if equipped)

- Turn on or off the Radio/Media.
- Press and hold the button to turn off the screen and sound.
- Turn the knob to adjust the system volume (except for navigation sound).

Option B

POWER button
(POWER)
(if equipped)

- Turn on or off the Radio/Media.
- Press and hold the button to turn off the screen and sound.

VOLUME button
(VOL)
(if equipped)

- Press the button to adjust the system volume (except for navigation sound).

MAP button

- Returns to the current location on the map.
- While in guidance on the navigation screen, press to repeat the voice guidance.





NAV button

- Displays the Navigation Menu screen.
 - Press and hold the button to display the Places screen.
▶ See "Searching by keyword."
-

RADIO button (if equipped)	<ul style="list-style-type: none">• Turns on the radio.• When the radio is on, press the button repeatedly to toggle between FM, AM and SiriusXM modes.• Press and hold the button to display the Radio/Media selection window (if equipped).
MEDIA button	<ul style="list-style-type: none">• Runs the connected media.• Press and hold the button to display the Radio/Media selection window.
SEEK/ TRACK button (if equipped)	<ul style="list-style-type: none">• While listening to the radio, change the station.• While playing media, change the track/file. Press and hold to rewind or fast forward (except for the Bluetooth audio mode).
Custom button (☆)	<ul style="list-style-type: none">• Runs the user-defined function.• Press and hold the button to display the function settings screen.
SETUP button (if equipped)	<ul style="list-style-type: none">• Displays the Settings screen.• Press and hold the button to display the version information screen.
Search lever/knob (TUNE/FILE) (if equipped)	<ul style="list-style-type: none">• While listening to the radio, adjust the frequency or change the broadcasting channel.• While playing media, scan music or files.• During scanning, select the current channel, music or file.• On the map screen, zoom in or out on the map (if activated).
System Reset button	<ul style="list-style-type: none">• Restarts the system.

Steering wheel remote control

 The shape may differ depending on the vehicle model and specifications. For more information, see "Quick Reference Guide" that is separately provided.

Voice Recognition button 	<ul style="list-style-type: none">• Press to start voice recognition.• Press and hold to start voice recognition of a connected smartphone via phone projection. (The button's operation may vary depending on smartphone specifications.)
MODE button	<ul style="list-style-type: none">• Press the button repeatedly to change the system mode (radio, media, etc.).• Press and hold the button to display the function settings screen.
Volume lever/button (+/-)	<ul style="list-style-type: none">• Adjust the volume.
Mute button 	<ul style="list-style-type: none">• Press the button to mute or unmute the volume (except for navigation sound).• Press the button to pause or resume playback.
Move lever/button (^/~/v)	<ul style="list-style-type: none">• While listening to the radio, switch between the stations on the preset list. Press and hold to search for a station.• While playing media, change the track/file. Press and hold to rewind or fast forward (except for the Bluetooth audio mode).
Option A	
Call button 	<ul style="list-style-type: none">• Before connection of Bluetooth: Press to display the Bluetooth connection window.• After connection of Bluetooth: Press to display the recent calls list. To redial the last call number, press and hold the button. When a call comes in, press to answer the call.• During a Bluetooth call: Press to switch to Call Waiting. Press and hold to switch between the system and mobile phone.
End Call button  (if equipped)	<ul style="list-style-type: none">• After connection of Bluetooth: When a call comes in, press to reject the call.• During a Bluetooth call: Press to end a call.

Option B

Call button ()

- Before connection of Bluetooth: Press to display the Bluetooth connection window.
- After connection of Bluetooth: Press to display the recent calls list. To redial the last number, press and hold the button.
- When a call comes in: Press to answer a call.

End Call button () (if equipped)

- During a Bluetooth call: Press to end a call.
- When a call comes in: Press and hold to reject a call.

Custom button () (if equipped)

- Runs the user-defined function.
- Press and hold the button to display the function settings screen.

N button () (if equipped)

- Runs the user-defined function.
 - Press and hold the button to display the function settings screen.
-

Turning on/off the system

The following explains how to turn on or off the system. Before using the system, be sure to read the user's manual for safe and convenient manipulation.

Turning on the system

- 1 Turn on the vehicle.
- 2 When a safety warning message appears, read it and press **Confirm**.
 - ✎ To change the display language, press **Language**.

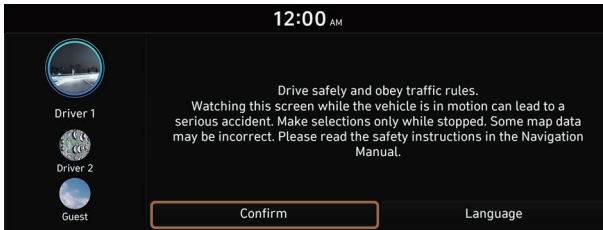

- ✎ The screen may differ depending on the vehicle model and specifications.
- ✎ To set the user profile, note the following. ► See "Using the First Run Setup."

Turning off the system

To turn off the system while driving, press and hold the Power button on the panel.

The screen and sound will be turned off.

- ✎ To use the system again, press the Power button.
- ✎ When a specified period of time elapses after turning off the vehicle, the system automatically shuts down. When you open the driver's door, the system immediately shuts down.





Warning

- Driving while distracted can result in a loss of vehicle control that may lead to an accident, severe bodily injury, or death. The driver's primary responsibility is the safe and legal operation of the vehicle, and the use of any vehicle systems, including the touch screen and steering wheel controls, which take the driver's eyes, attention, and focus away from the safe operation of the vehicle, or which are not permissible by law, should never be used during the operation of the vehicle.
- Some functions may not be active while driving to ensure safety. Those functions run only when the vehicle is stationary. In order to use them, first stop the vehicle.
- When the screen is not displayed, the volume is muted, or other system failures occur, immediately stop using the system. When you use the faulty system continuously, it may cause fire, electric shock, or fatal system failure.

Caution

- The system can be turned on even when the ignition switch is in "ACC" or "ON." However, when you use the system without turning on the vehicle for a long time, it may cause battery discharge. To use the system for a long time, be sure to turn on the vehicle.
- When you use the system with the vehicle turned off, the battery warning message appears. The warning message disappears as soon as you turn on the vehicle.



-  The screen may differ depending on the vehicle model and specifications.
-  When you turn off and on the vehicle, the system is turned on with the mode and settings used when the vehicle was turned off.
-  To prevent audio from playing loud when you turn on the vehicle, adjust the system volume to an adequate level.
-  To automatically decrease the system volume, move to the All Menus screen and press **Setup ► Sound ► Premium Sound ► Start-up Volume Limit** to set the function.

Using the touch screen

This system is equipped with a touch-enabled screen. You can use various practices by using this feature.

Warning

Do not use the touch screen while driving as this will divert your attention away from the safe operation of the vehicle. You may lose your steering control which could cause an accident and severe bodily injuries.

Caution

- Do not press the touch screen with excessive force or a sharp object. The touch screen may become damaged.
- Do not let any electrically conductive material contact the touch screen, and do not place any objects that generate electromagnetic waves, such as wireless chargers or electronic devices, near the touch screen. The system may work incorrectly due to electromagnetic effects, which may cause the touch screen to malfunction.

 The touch screen does not respond when you are wearing gloves. Take off the gloves or wear electrostatic touch gloves.

"Press" gesture

Lightly press the desired item and release the finger.

The corresponding function is run or the corresponding menu is selected.

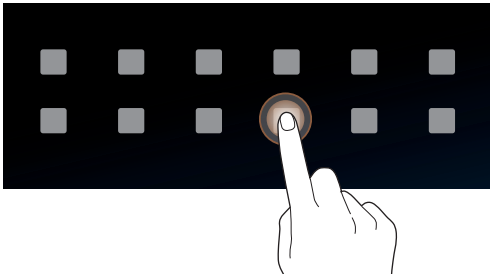

"Press and hold" gesture

Press and hold the desired item.

It is used to fast forward or rewind during playback.

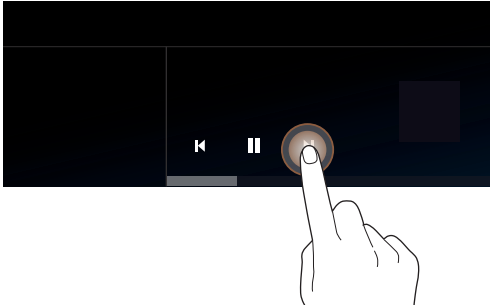

"Slide" gesture

On the media playback screen, press the slide bar to change the playback position.

You can change the playback position during playback.

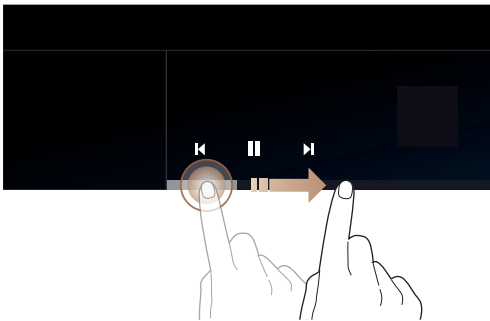

"Drag" gesture

Press and hold the desired item and drag it to another position.

The selected item moves to the new position.

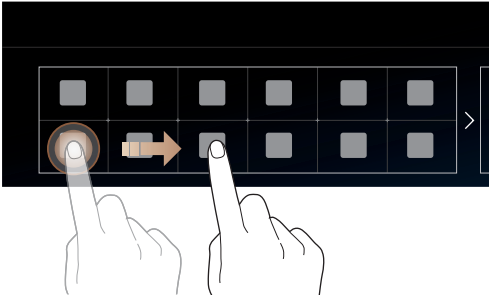

"Swipe" gesture

Lightly swipe the screen in the desired direction.

It is used to move fast vertically or horizontally across the menu screen or options list.

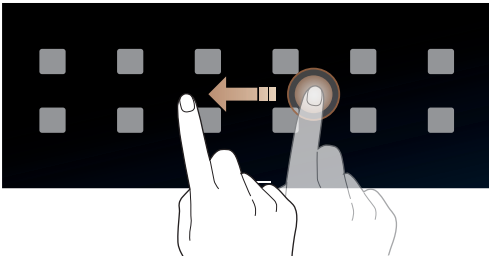

"Spread/pinch" gesture

On the map screen, press and hold the screen with two fingers and spread or pinch the fingers.

It is used to zoom in or out the map.

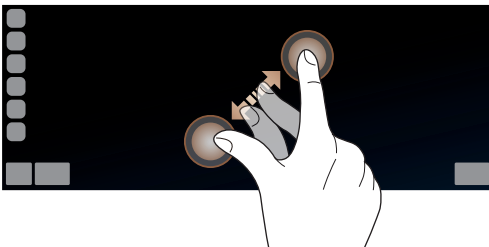

Using the Home screen

The Home screen is the basic screen provided by the system and displays the current time and other basic information.

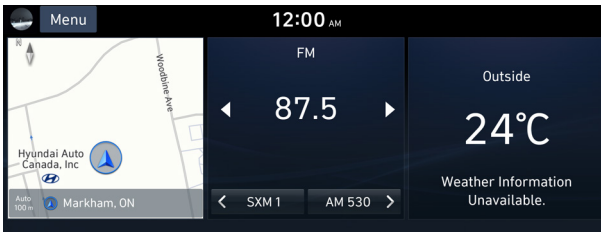

Type1

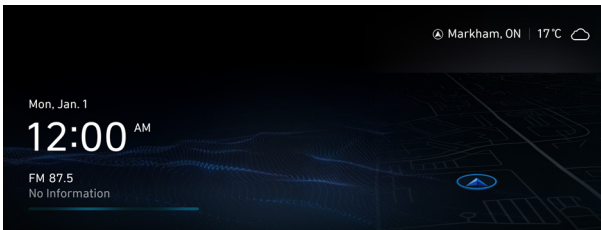

Type2

 The displayed screen or menu items may differ, depending on the vehicle model and features. Check the screen type for your vehicle model and view the appropriate instructions.

Home screen (Type1)

The layout of the Home screen is as follows:

✍ To return to the Home screen from other screens, press .



- 1 Current time. Depending on the vehicle model or specifications, time and date display may vary. Press to access the time and date settings screen. ► See "Date/Time."
- 2 System status icons. Status icons are not included in the screenshots in this guide, because their appearance may differ depending on the system status or mode. ► See "System status indicator icons."
- 3 Displays active widgets. When a widget is pressed, the corresponding function runs in full screen. ► See "Editing widgets on the Home screen (Type1)."
- 4 Displays the specified user profile image. When the image is pressed, the user profile setting screen appears (if equipped). ► See "Configuring the user profile settings (Type1) (if equipped)."
- 5 The list of menu items appears.
 - **Edit Home Widgets:** Used to edit the types and positions of widgets on the Home screen.
 - **Edit Home Icons:** Used to edit the types of icons on the Home screen.
 - **User's Manual on Web (QR Code):** Displays the QR code that provides access to the online user manual for the system.

✍ The screen may differ depending on the vehicle model and specifications.

✍ To see all menus on the Home screen, swipe the screen to the left.

Home screen (Type2)

The Home screen layout is as follows:

✎ To return to the Home screen from other screens, press .

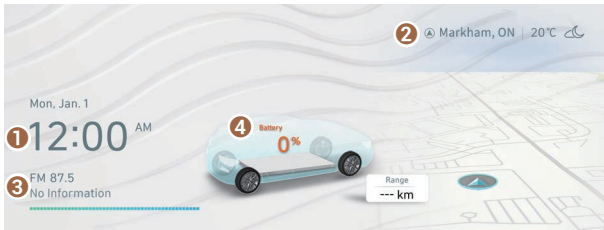
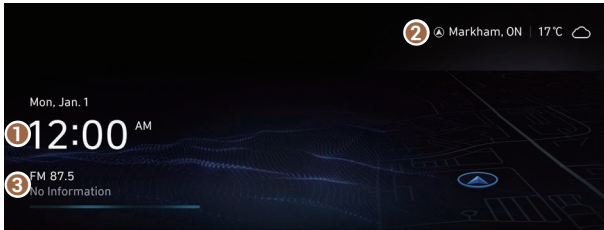

(for IONIQ 5 only)

- 1 Displays the date and time.
- 2 Displays weather, and other information.
- 3 Displays Radio/Media information.
- 4 If you press the vehicle image, the Electric Vehicle screen appears.

✎ The screen may differ depending on the vehicle model and specifications.

✎ To display the map screen, press the map area.

Editing widgets on the Home screen (Type1)

You can edit the types and positions of the widgets to display on the Home screen.

- 1 At the upper left of the Home screen, press **Menu ► Edit Home Widgets**.
- 2 Perform any of the following methods:
 - To change the widget type, press and hold the desired widget on **1** List of widgets and then drag it to **2** Widget area.
 - To change the listed order for widgets, press and hold a widget on **2** Widget area and then drag it to the desired position.



1 List of widgets

2 Widget area

✎ The screen may differ depending on the vehicle model and specifications.

✎ To initialize the types and positions of widgets, press **Reset**.

Editing icons on the Home screen (Type1)

You can see the icon list on the Home screen and change the locations for icons.

- 1 At the upper left of the Home screen, press **Menu ► Edit Home Icons**.
- 2 To change the location of an icon, press and hold, and drag the icon to the desired position.

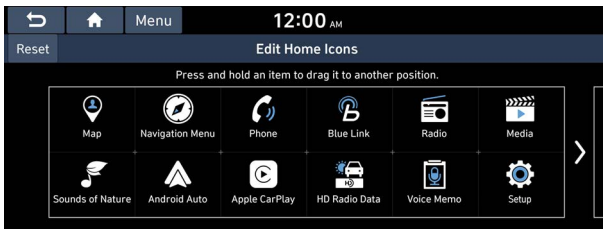

✎ The screen may differ depending on the vehicle model and specifications.

✎ To initialize the positions of icons, press **Reset**.

Editing the icons on the Home screen (Type2)

You can see the icon list on the All screen and change the locations for icons.

- 1 At the upper left of the All Menu screen, press  ► **Edit Home Icons**.
- 2 To change the location of an icon, press and hold, and drag the icon to the desired position.

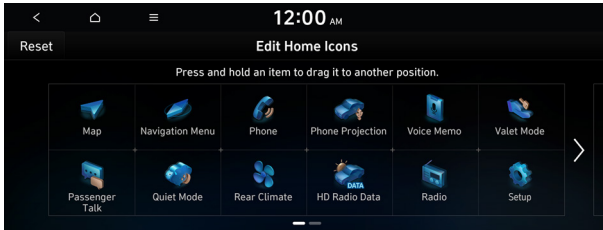

- ✎ The screen may differ depending on the vehicle model and specifications.
- ✎ To initialize the positions of icons, press **Reset**.

Accessing the All Menu screen

You can see all menus on the Home screen.

Press and gently swipe the Home screen to the left as shown below.

The All Menu screen appears. You can see the list of all functions of the system.

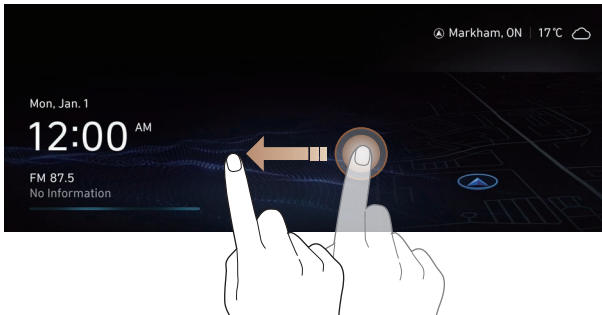

- ✎ The screen may differ depending on the vehicle model and specifications.

Using the split screen (if equipped)

You can set to display various information such as map, Radio/Media info, driving info, and clock on the split system screen.

Opening the split screen

Press the split screen button.

The split screen appears on the right.

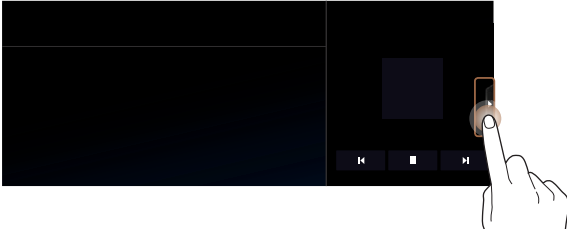

 To open split screens, press **Split Screen** on the menu at the top of the screen.



Editing the split screen

You can change information on the split screen.

Press and hold, and then drag the split screen up or down to select the desired information item.

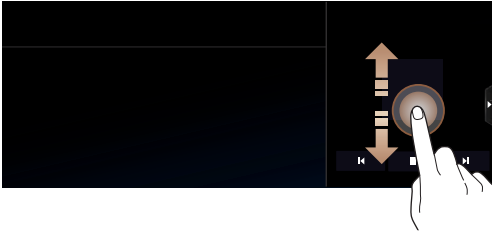

Closing the split screen

Press the split screen button when the split screen is open.

 To close split screens, press **Split Screen** on the menu at the top of the screen.

MEMO

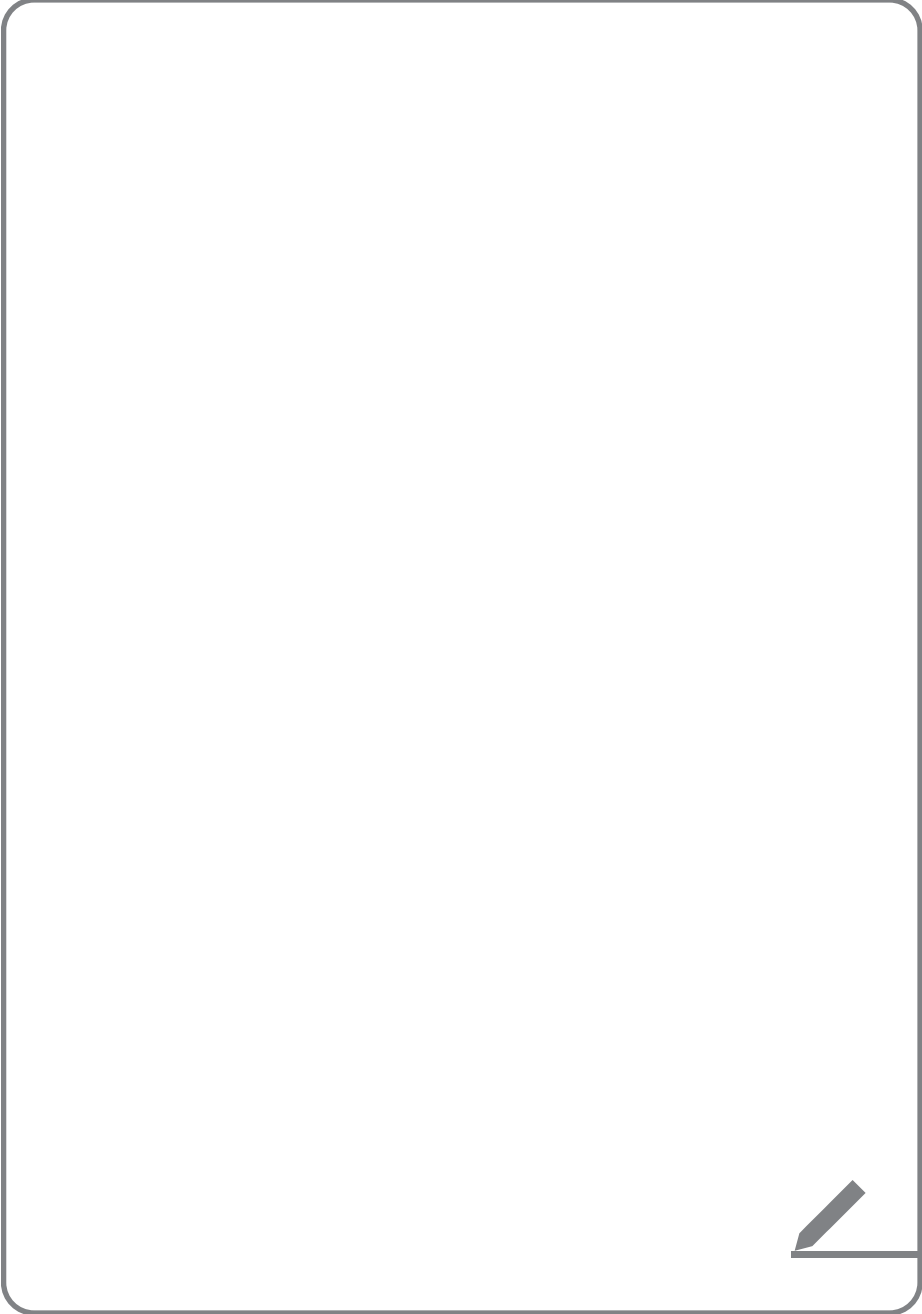

02

Useful functions

Using the First Run Setup

Using the phone projection function

Viewing the driving assistance screen

Using the climate control function

Using the rear-seat climate control function

Using the rear-seat conversation mode

Using the rear-seat quiet mode

Playing Sounds of Nature

Using the HD Radio™ Data

Viewing the driving information

Viewing notifications

Using the Valet mode

Using N mode



Using the First Run Setup

You can configure the system settings for each driver when multiple people are using the vehicle.

In First Run Setup, you can configure the values to display on the screen such as user name, language, and map display method.

- 1 When a safety warning message appears, read it, select the driver image, and then press **Confirm**.

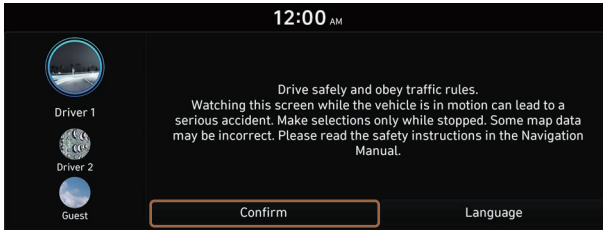

- ✎ When you log in as guest, you cannot configure the profile settings. To set a different profile, select another user.
- ✎ You can register up to 2 users.

- 2 When the First Run Setup screen appears, press **Start**.

- ✎ To use the default settings without changing the environment, press **Skip**.

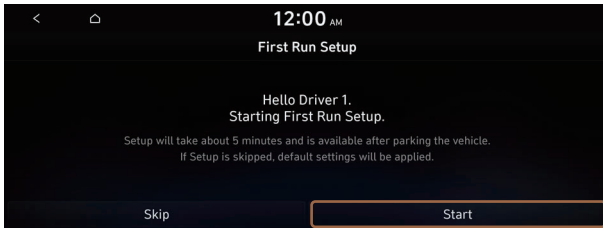

- 3 Set the language to display on the screen and then press **Next**.

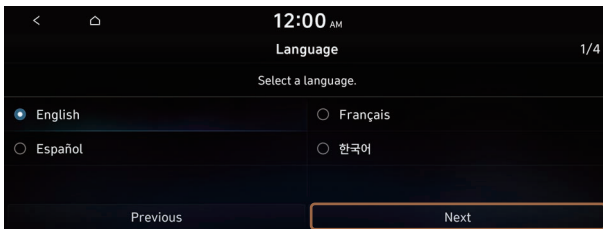

4 Set the keyboard type for text entry and then press **Next**.

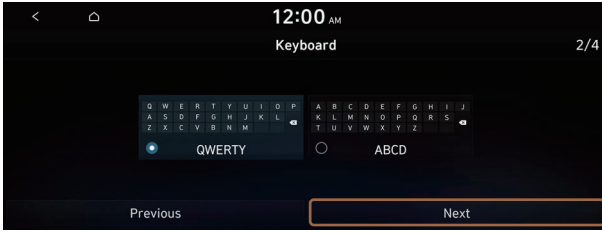

5 To set the driver's name, press **Rename**.

The name change screen appears.

 To proceed with First Run Setup without changing the driver's name, press **Next**.

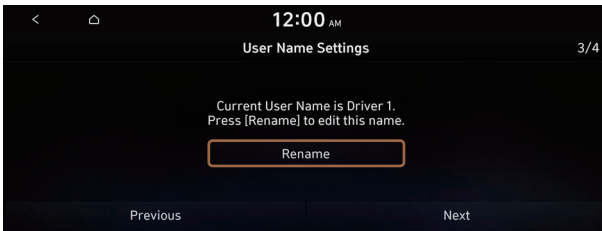

6 Set the map display method and then press **Next**.

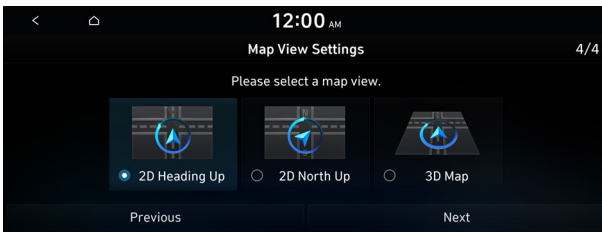

- **2D Heading Up:** The map is rotated depending on the driving direction.
- **2D North Up:** Displays the map with the north fixed at the top.
- **3D Map:** The map is rotated depending on the driving direction and it is displayed in three dimensions.

7 When the First Run Setup screen appears, press **OK**.

Displays the Home screen.

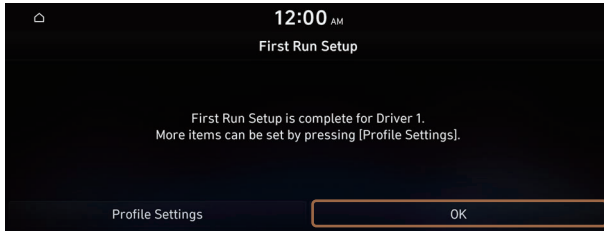

 To set the detailed user information and operation environment, press **Profile Settings**.

Using the phone projection function

When you connect an Android smartphone or iPhone to the vehicle with a USB cable, you can run and control Apps on the phone through the widescreen using its user-friendly interface.



Warning

Do not adjust or set up any phone settings while driving. You may lose your steering control which could cause an accident and severe bodily injuries.



Caution

Using an approved USB cable provided by your smartphone manufacturer is recommended. Using unapproved USB cables may cause a phone projection error or a system malfunction.

Pairing to an Android smartphone via Android Auto

When you connect an Android smartphone to the vehicle with Android Auto, you can run and control Apps on the phone through the widescreen using its user-friendly interface.

- 1 To use Android Auto, first check the following.
 - Visit the Android Auto website at <https://www.android.com/auto> to check the list of countries, device types, and models that support Android Auto.
 - Download and install the Android Auto App from Google Play Store. It is not possible to install Android Auto in countries that do not support the feature.
- 2 On the All Menus screen, press **Setup ► Device Connections ► Phone Projection Settings ► Android Auto** and select the **Enable Android Auto** checkbox.

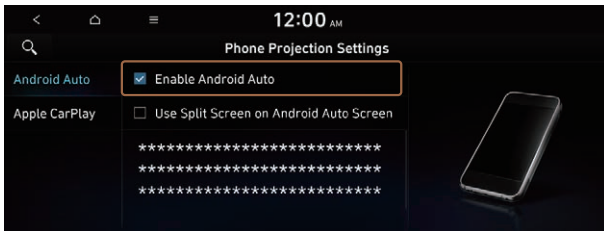

✍ The screen may differ depending on the vehicle model and specifications.

✍ Select **Use Split Screen on Android Auto Screen** to show split screen when using Android Auto.

- 3 Connect a smartphone to the USB port on the vehicle by using the provided USB cable.

✍ When the connection is made for the first time, the system screen displays a notification window. Check the details and then press **OK**.

✍ To end the Android Auto and disconnect from the smartphone, remove the USB cable from the system.

Caution

Do not repeatedly connect and remove the USB connector within a short time. It may cause device errors or system failures.

- 4 When the smartphone is locked, unlock it first and then consent to the use of Android Auto.

When the smartphone is recognized successfully, the **Android Auto** menu is activated on the All Menus screen.

Using the Android Auto

1 On the All Menus screen, press **Android Auto**.

2 Perform the desired function.

- To run the functions for phone, music, or navigation on the smartphone, press the corresponding app icon.

✍ When you are using your smartphone's navigation via phone projection, sounds from both the system's radio/media function and the navigation will be output through your vehicle's speakers. When you use the Volume knob/button while both sounds are being output, the navigation volume is adjusted first.

- To use the Google voice recognition, press and hold the Voice Recognition button on the steering wheel.

✍ By pressing the **[MODE]** button on the steering wheel, you can run the media App on your smartphone as well as the Radio/Media mode of the system.

✍ To specify which functions to run when the **[MODE]** button on the steering wheel is pressed, press and hold the **[MODE]** button to display the settings screen.

✍ By pressing the Call button on the steering wheel, you can make a call via Bluetooth connection.

✍ When phone projection is active, you cannot change the phone projection settings. To change the settings, remove the USB cable from your system.

✍ The icons on the screen are subject to change according to the policy of Google Corporation.

✍ Apps or functions used through Android Auto are subject to change according to the policy of Google Corporation. For supportable functions, visit the Android website at <https://www.android.com/auto>.

✍ To use the functions on your smartphone with the minimized system settings, update the smartphone OS to the latest version.

✍ The recognition time may differ depending on the device type, firmware, and OS version.

✍ Charges may apply for any mobile data used while Android Auto is running.

✍ Some functions may not work properly depending on the network signal strength.

✍ Avoid interacting with the smartphone while using Android Auto.

✍ You cannot use the following functions when Android Auto is in use.

- USB mode
- Apple CarPlay
- Searches using the control panel or the steering wheel remote control

Pairing to an iPhone via Apple CarPlay

After you connect an iPhone to the vehicle with Apple CarPlay, you can run and control Apps on the phone through the system screen.

- 1 To use Apple CarPlay, first check the following:
 - For iPhone models that support Apple CarPlay, visit the Apple website at <https://www.apple.com/ios/carplay>.
 - Make sure Apple CarPlay and Siri are enabled in your iPhone settings. If you do not see options for Apple CarPlay or Siri, update to the latest iOS version.
- 2 On the All Menus screen, press **Setup ► Device Connections ► Phone Projection Settings ► Apple CarPlay** and select the **Enable Apple CarPlay** checkbox.

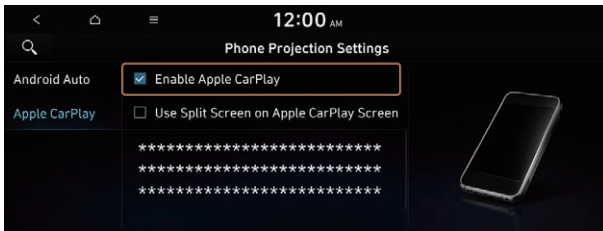

- ✍ The screen may differ depending on the vehicle model and specifications.
- ✍ Select **Use Split Screen on Apple CarPlay Screen** to show split screen when using Apple CarPlay.

- 3 Connect an iPhone to the USB port on the vehicle by using the provided USB cable.

- ✍ When the connection is made for the first time, the system screen displays a notification window. Check the details and then press **OK**.
- ✍ To end the Apple CarPlay and disconnect from the iPhone, remove the USB cable from the system.



Caution

Do not repeatedly connect and remove the USB connector within a short time. It may cause device errors or system failures.

- 4 When the iPhone is locked, unlock it first and then consent to the use of Apple CarPlay.

When the iPhone is recognized successfully, the **Apple CarPlay** menu is activated on the All Menus screen.

Using the Apple CarPlay

1 On the All Menus screen, press **Apple CarPlay**.

2 Perform the desired function.

- To run any of functions (phone, messaging, navigation, etc.) on your iPhone, press the corresponding function icon.

✍ When you are using your smartphone's navigation via phone projection, sounds from both the system's radio/media function and the navigation will be output through your vehicle's speakers. When you use the Volume knob/button while both sounds are being output, the navigation volume is adjusted first.

- To run the Siri voice recognition, press and hold the Voice Recognition button on the steering wheel.

✍ By pressing the [MODE] button on the steering wheel, you can run the media App on your smartphone as well as the Radio/Media mode of the system.

✍ To specify which functions to run when the [MODE] button on the steering wheel is pressed, press and hold the [MODE] button to display the settings screen.

✍ When you receive a call, press the Call button on the steering wheel to answer it.

✍ When phone projection is active, you cannot change the phone projection settings. To change the settings, remove the USB cable from your system.

✍ Apps or functions used through Apple CarPlay are subject to change according to the policy of Apple Corporation. For supportable functions, visit the Apple Corporation website at <http://www.apple.com/ios/carplay>.

✍ To use the functions on your smartphone with the minimized system settings, update the smartphone OS to the latest version.

✍ The recognition time may differ depending on the device type, firmware, and OS version.

✍ Charges may apply for any mobile data used while Apple CarPlay is running.

✍ Some functions may not work properly depending on the network signal strength.

✍ Avoid interacting with the smartphone while using Apple CarPlay.

✍ You cannot use the following functions when Apple CarPlay is in use.

- Bluetooth phone
- USB mode
- Android Auto
- Browsing using the Search lever/knob on the control panel (if equipped)

Viewing the driving assistance screen

You can see the view around the vehicle through the system screen.

 The displayed screen may differ depending on the vehicle model.

Warning

When backing up, make sure to follow the guidelines below:

- Before entering your vehicle, always check the area behind your vehicle.
- Do not solely rely on the rear view camera when backing up. Always ensure that it is safe to back up by checking behind you and looking in the rearview mirrors.
- Always back up slowly and stop immediately if you suspect that a person, especially a child, might be behind you.

Caution

Objects on the screen may not be as close or far as they appear. Be sure to check the rear, left, and right sides with your own eyes for safety.

Rear view screen

- 1 Press the "R" (Reverse) button shifter (or move the shift lever to "R" in a previous vehicle model) with the vehicle turned on.





The system automatically displays the rear view with parking assist guidelines.

- 2 Safely park your vehicle, checking the rear view and guidelines.

 The example may differ from the actual screen display.



1 VIEW icon

-  (Home icon): Displays the Home screen.
-  (Rear view icon): Press the icon to display the desired view.
-  (Settings icon): Used to adjust the brightness and contrast of camera images.
 To select the information to display on the screen, press **Display Contents** (if equipped).

2 Parking Distance Warning or Split Screen (if equipped)

- **Parking Distance Warning:** Provides a visual warning in color and an audible warning according to the level of collision risk, based on the distance from an ambient obstacle.
- **Split Screen:** The split screen appears.



 Available settings may differ depending on the vehicle model and specifications.

 You can set to display the rear camera display even when you change the shift position other than "R" (Reverse) after reversing. To change rear camera operation settings, On the All Menus screen, press **Setup ▶ Display ▶ Extend Rear Camera Use** (if equipped).

 Noting the parking assist guide lines based on the steering, you can see the moving direction.



 A warning sound is heard when the vehicle approaches obstacles while parking. When you set to automatically lower the audio volume while parking, it can prevent accidents caused by failure to hear the warning sound. On the All Menus screen, press **Setup ▶ Sound ▶ Driver Assistance ▶ Parking Safety Priority**.

 When you press the  button with the shift position in "P" (Park), you can see the rear view (if equipped).



Viewing the rear view (if equipped)

You can see the rear view through the system screen.

- 1 On the rear view screen, press .
- 2 Press the icon to display the desired view.

 The guidelines appear on the rear view.

- Displays the space required to open the trunk (tailgate). After a parking, check whether the space is sufficient to open the trunk (tailgate) and there is no obstacle.
- Displays the extension line from the center of the vehicle. According to the steering direction, the moving direction of the center is displayed on the screen.

Icon	Description
	Displays the rear top view.
	Displays the rear view (default).

Configuring rear view settings (if equipped)

- 1 On the rear view screen, press .
- 2 Select and then change the settings.
 - To select the information to display on the screen, press **Display Contents** (if equipped).
 - To adjust the brightness and contrast of the rear view screen, press **Display Settings**. To initialize all Rear View screen settings, press **Reset**.

Surround View Monitor (if equipped)

You can check the surroundings by using multiple cameras on the vehicle.

 Use the +/- button on the right of the screen to zoom in or out.



Viewing the surround view while driving

1 In order to see the surround view, press the  or  button.





The system displays both the front view and surround view.

 The surround view monitor function operates only when any of the following conditions are met.

- The driving speed is below 10 km/h or 15 km/h with the shift position in "D" (Drive) (if equipped).
- The vehicle is stationary and the shift position is in "D" (Drive) or "N" (Neutral).

 You can use Remote Smart Parking Assist by long pressing the  button. For more information, refer to the owner's manual that is separately provided (if equipped).

2 Press the icon to get a view in the desired direction.

Icon	Description
	Displays the zoom-in front top view and top view.
	Displays the front wide view and top view (default).
	Display the front blind spot view and top view.
	Displays 3D and top views of the vehicle surroundings (if equipped).
	Displays the surround view settings.

 When any door or trunk (tailgate) is open or outside rear view mirrors are folded, an alert icon appears on the screen.

 To turn off the surround view screen, press the  or  button.





Viewing the surround view while reversing

- 1 Press the "R" (Reverse) button shifter (or move the shift lever to "R" in a previous vehicle model) with the vehicle turned on.

The system displays the rear view of the vehicle.

- ✎ The surround view monitor function is not available when you change the shift position to "P" (Park).
- ✎ When you press the [**R**] button with the shift position in "P" (Park), you can see the rear view (if equipped).

- 2 Press the icon to get a view in the desired direction.



Icon	Description
	Displays the zoom-in rear top view and top view.
	Displays the rear wide view and top view (default).
	Display the rear blind spot view and top view.
	Displays 3D and top views of the vehicle surroundings (if equipped).
	Displays the surround view settings.

Configuring the surround view monitor settings

- 1 On the surround view screen, press .
- 2 Select and then change the settings.
 - To select the information to appear on the video, press **Display Contents** (e.g. Top View Parking Guidance, Rear View Parking Guidance, Parking Distance Warning).
 - To select the default view for top view monitoring, press **Top View Default Mode** (if equipped).
 - To select the default view for using the surround view monitor function while driving, press **Front View Default Mode** (if equipped).
 - To adjust the brightness and contrast of the Surround View image, press **Display Settings** (if equipped).
 - To set the information to display on the Surround View screen and adjust or reset the brightness and contrast of the image, on the All Menus screen, press **Setup ► Vehicle ► Driver Assistance ► Parking Safety ► Camera Settings** (if equipped).

Using the climate control function (if equipped)

You can check and adjust the climate system settings on the screen.

-  For more information about how to use the heater and air conditioner, refer to Owner's Manual of the vehicle.
-  When you manipulate the climate control system while using the product, the climate settings appear on the upper part of the screen (if equipped).
-  The screen may differ depending on the vehicle model and specifications.

- 1 Perform any of the following methods:
 - Press the **[CLIMATE]** button on the climate control system.
 - On the All menus screen, press **Climate**.

2 Select and then change the settings.

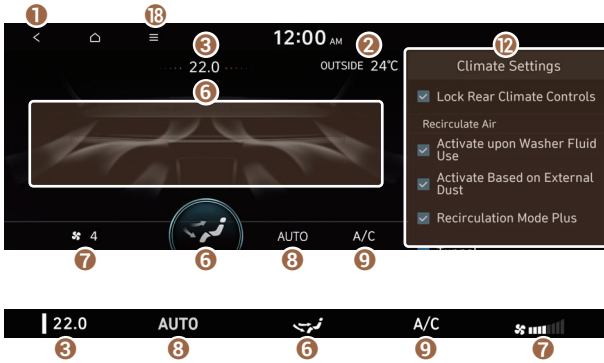

Option A

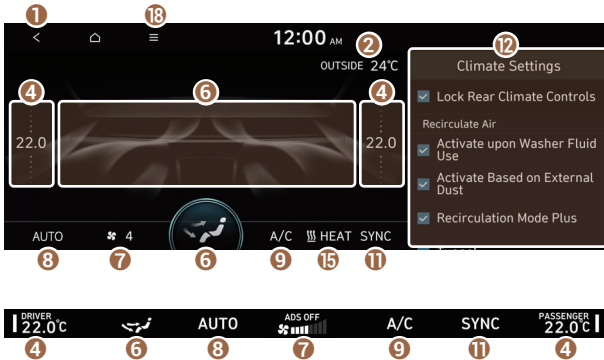

Option B

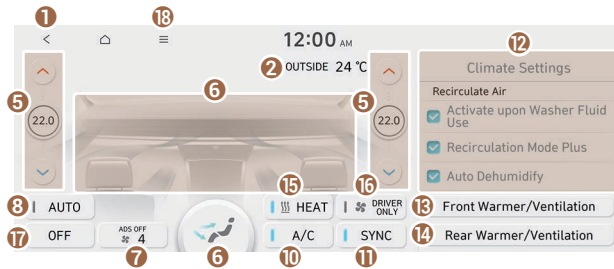

Option C

- 1 Returns to the previous step.
- 2 Shows the outside temperature of the vehicle.
- 3 Shows the current set temperature.
- 4 Shows the set temperature for each seat.
- 5 Adjust the temperatures for each seat.
- 6 Shows the current airflow direction.
- 7 Shows the current fan speed.
- 8 Shows whether the automatic temperature control function is on or off.
- 9 Shows whether the A/C is on or off.
- 10 Turns on or off the air conditioner function.
- 11 Shows whether the SYNC function, which syncs the driver's seat temperature with the passenger seat temperature, is on or off.
- 12 Configure specific climate control function settings.
 - ✍ Available settings may differ depending on the vehicle model and specifications.
- 13 Displays the front-seat warmer/ventilation settings screen (if equipped).
 - ✍ Available settings may differ depending on the vehicle model and specifications.
- 14 Displays the rear-seat warmer/ventilation settings screen (if equipped).
 - ✍ Available settings may differ depending on the vehicle model and specifications.
- 15 Turn on or off heaters (if equipped).
- 16 Turn on or off the driver seat-only climate control mode (if equipped).
- 17 Turn off the climate control function (if equipped).
- 18 The list of menu items appears.
 - **Display Off:** Turns off the screen. To switch the screen back on, press the screen or briefly press the power button.
 - **Front Warmer/Ventilation:** Displays the front-seat warmer/ventilation settings screen (if equipped).
 - **Rear Warmer/Ventilation:** Displays the rear-seat warmer/ventilation settings screen (if equipped).
 - **Climate Settings:** Configure specific climate control function settings (if equipped).
 - **User's Manual on Web (QR Code):** Displays the QR code that provides access to the online user manual for the system.

✍ The temperature of the climate system can be adjusted by 0.5 °C increments. When the temperature is set to the lower limit or upper limit, "LOW" or "HIGH" appears on the screen.

✍ Available settings may differ depending on the vehicle model and specifications.

Using the Front Heat/Ventilation and Steering Wheel Heating Control (if equipped)

You can adjust the seat warmer/ventilation settings to make your driving environment more pleasant. You can also turn on or off the steering wheel warmer function.

- 1 On the All Menus screen, press **Warmer/Ventilation**.
- 2 Select to view the item.



- 1 Returns to the previous step.
- 2 Configure specific climate control function settings.
 - Available settings may differ depending on the vehicle model and specifications.
- 3 Turn on or off the warmer or ventilation for each seat.
- 4 Turn on or off the steering wheel warmer function.
- 5 Displays the front-seat climate control settings screen.
- 6 Displays the rear-seat warmer/ventilation settings screen.
 - Available settings may differ depending on the vehicle model and specifications.
- 7 The list of menu items appears.
 - **Display Off:** Turns off the screen. To switch the screen back on, press the screen or briefly press the power button (if equipped).
 - **Front Climate:** Displays the front-seat climate control settings screen (if equipped).
 - **Rear Warmer/Ventilation:** Displays the rear-seat warmer/ventilation settings screen (if equipped).
 - Available settings may differ depending on the vehicle model and specifications.
 - **Climate Settings:** Configure specific climate control function settings (if equipped).
 - **User's Manual on Web (QR Code):** Displays the QR code that provides access to the online user manual for the system.

Using the rear-seat climate control function

(if equipped)

You can check or set the rear-seat climate status on the system screen.

1 Perform any of the following methods:

- Press the **[REAR]** button on the climate control system.
- On the All Menus screen, press **Rear Climate**.

2 Select and then change the settings.

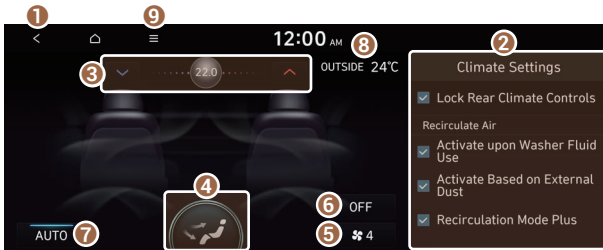

For automatic temperature control

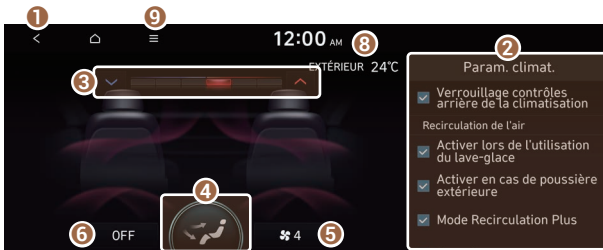

For manual temperature control

- 1 Returns to the previous step.
- 2 Configure specific climate control function settings.
 - ✍ Available settings may differ depending on the vehicle model and specifications.
- 3 Can set the inside temperature.
- 4 Can adjust the air direction.
- 5 Can adjust the fan speed.
- 6 Turn off the climate control function (if equipped).

- 7 Turn on the AUTO mode. If you change the climate control status using another button, the AUTO mode automatically turns off.
- 8 Shows the outside temperature of the vehicle.
- 9 The list of menu items appears.
 - **Display Off:** Turns off the screen. To switch the screen back on, press the screen or briefly press the power button.
 - **User's Manual on Web (QR Code):** Displays the QR code that provides access to the online user manual for the system.

 Available settings may differ depending on the vehicle model and specifications.

Using the Rear Heat/Ventilation Control (if equipped)

You can adjust the seat warmer/ventilation settings to make your driving environment more pleasant.

- 1 On the All Menus screen, press **Warmer/Ventilation**.
- 2 Select to view the item.



- 1 Returns to the previous step.
- 2 Configure specific climate control function settings.
 -  Available settings may differ depending on the vehicle model and specifications.
- 3 Turn on or off the warmer or ventilation for each seat.
- 4 Displays the front-seat climate control settings screen.
- 5 Displays the front-seat warmer/ventilation settings screen.

 Available settings may differ depending on the vehicle model and specifications.

- 6 The list of menu items appears.
- **Display Off:** Turns off the screen. To switch the screen back on, press the screen or briefly press the power button (if equipped).
 - **Front Climate:** Displays the front-seat climate control settings screen (if equipped).
 - **Front Warmer/Ventilation:** Displays the front-seat warmer/ventilation settings screen (if equipped).
 - ✎ Available settings may differ depending on the vehicle model and specifications.
 - **Climate Settings:** Configure specific climate control function settings (if equipped).
 - **User's Manual on Web (QR Code):** Displays the QR code that provides access to the online user manual for the system.

Using the rear-seat conversation mode

(if equipped)

When the driver's voice cannot be delivered well to the rear seat, you can use the microphone of the driver's seat for smooth communication.

1 On the All Menus screen, press **Passenger Talk**.

The passenger talk icon appears at the top right of the system screen to display its status.

2 Make conversation through the microphone of the driver's seat.

✎ To end the Passenger Talk mode, press **End**.

✎ When you move to another screen without pressing **End**, shortly press the End Call button on the steering wheel to end the passenger talk function.

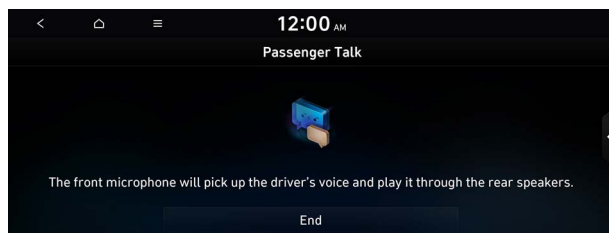

✎ When the Passenger Talk mode is active, the Radio/Media functions are unavailable.

✎ To access the online user's manual on the Passenger Talk screen, press  **User's Manual on Web (QR Code)** and then scan the displayed QR code.

Using the rear-seat quiet mode (if equipped)



To allow occupants in the rear seat to have rest and sleep, you can set to adjust the system volume.

- 1 On the All Menus screen, press **Quiet Mode**.
- 2 Press **Quiet Mode**.

The audio volume in the rear seat is muted. When the volume for the front seats is set too high, the volume decreases automatically.

 To end the Quiet mode, press **Quiet Mode** once more.



-  The screen may differ depending on the vehicle model and specifications.
-  To access the online user's manual on the Quiet Mode screen, press  ► **User's Manual on Web (QR Code)** and then scan the displayed QR code.

Playing Sounds of Nature

Listen to the calming sound of rain, waves, and more to relax while driving by turning on a Sounds of Nature.

- 1 On the All Menus screen, press **Media ▶ Sounds of Nature**.
- 2 Select from the Sounds of Nature list to play.

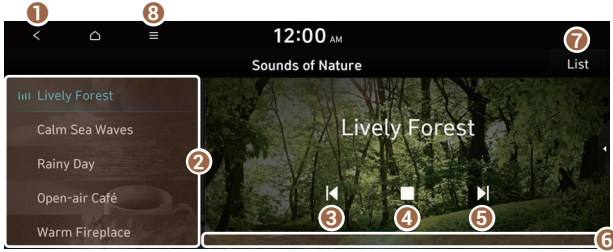

- 1 Returns to the previous step.
- 2 Select and play Sounds of Nature.
- 3 Play the previous sound.
- 4 Stop or play playback.
- 5 Play the next sound.
- 6 You can check the playback status of Sound of Nature.
- 7 Select and play Sounds of Nature.
- 8 The list of menu items appears.
 - **Display Off:** Turns off the screen. To switch the screen back on, press the screen or briefly press the power button.
 - **Media Sources:** Open the Radio/Media selection window.
 - **Sound Settings:** Displays the system sound settings screen.
 - **User's Manual on Web (QR Code):** Displays the QR code that provides access to the online user manual for the system.
 - **Split Screen:** Can turn on or off the split screen mode.

- ✍ Playing Sounds of Nature will mute or pause other sound effects and music that may be active at the moment.
- ✍ Incoming or outgoing calls will pause Sounds of Nature playback.
- ✍ The sound effect settings button may appear on the screen depending on the amp specifications.

Using the HD Radio™ Data

You can access an array of information with HD radio data such as HD Radio™.

✍ HD radio data are available only in metropolitan areas.

- 1 On the All Menus screen, press **HD Radio Data**.
- 2 Perform any of the following methods:



- 1 Returns to the previous step.
- 2 Can see traffic information by using HD Radio data. ► See "Viewing traffic information using HD radio data."
- 3 Can see weather information from the Doppler Radar. ► See "Viewing weather information using Doppler weather radar."
- 4 Can see fuel price information by using HD Radio data (if equipped). ► See "Viewing fuel price information using HD radio data (if equipped)."
- 5 The list of menu items appears.
 - **Display Off:** Turns off the screen. To switch the screen back on, press the screen or briefly press the power button.
 - **User's Manual on Web (QR Code):** Displays the QR code that provides access to the online user manual for the system.
 - **Split Screen:** Can turn on or off the split screen mode.

✍ The screen may differ depending on the vehicle model and specifications.

Viewing traffic information using HD radio data

- 1 On the All Menus screen, press **HD Radio Data**.
- 2 Press **Traffic**.
- 3 Select an item from the traffic information list to see the details.
 - 📍 To see traffic information along with your current route or to see all available traffic information, press **On Route**.
 - 📍 To select the types of traffic information to see, press **Filter**.

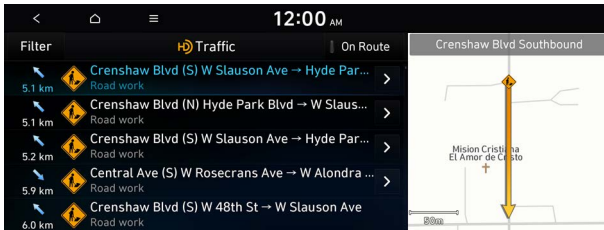

- 4 Check the traffic information details.

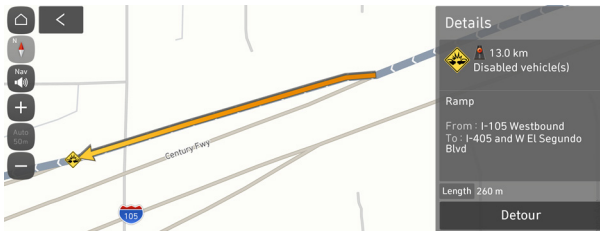



- 📍 Traffic information for border crossings and speed limits in local roads may not be accurate. Use the information at your discretion.

Viewing weather information using Doppler weather radar

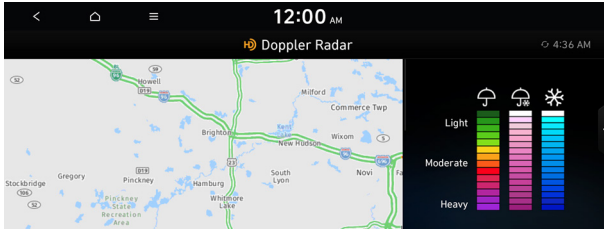
- 1 On the All Menus screen, press **HD Radio Data**.
- 2 Press **Doppler Radar**.
- 3 See the weather condition details in the HD Radio coverage area.



Viewing fuel price information using HD radio data (if equipped)

- 1 On the All Menus screen, press **HD Radio Data**.
- 2 Press **Fuel Prices**.
- 3 Search nearby gas stations, and check the current fuel prices.
 - ✎ To change the sorting order, press  on the drop-down list and then select the sorting criteria.
 - ✎ To see the latest information, press .

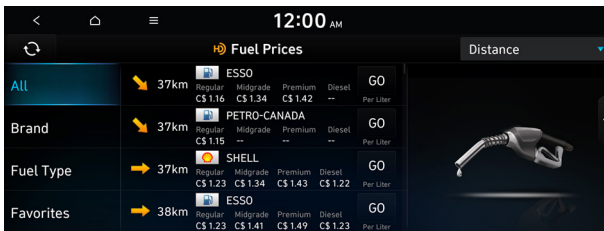

Viewing the driving information (if equipped)

You can analyze the driving patterns by checking the driving information such as driving time, distance, idle time, and vehicle speed distribution. Use this information to ensure safe and economical driving.

 This function is available only when your vehicle is stationary with the vehicle started.

1 On the All Menus screen, press **Driving Info**.

2 Check the driving information of your vehicle.

 To see the latest information, press .



 To access the online user's manual on the Driving Info screen, press **Menu ► User's Manual on Web (QR Code)** and then scan the displayed QR code.

Viewing notifications (if equipped)

View Bluelink notifications including the navigation and map update information.

✍ Subscribe to Bluelink to check the function. ▶ See "Subscribing to the service."

- 1 On the All Menus screen, press **Notifications**.
- 2 Select to view the item.

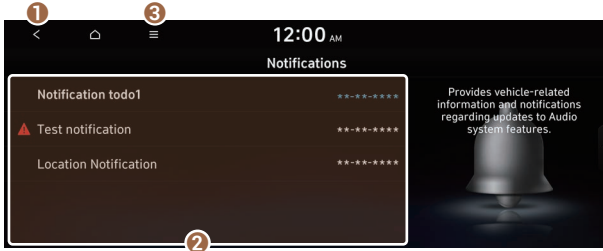

- 1 Returns to the previous step.
- 2 View the list of received notifications. Select from the list to view details.
 - ✍ Important notifications are marked with  next to the title.
 - ✍ You cannot display notification details while driving. Stop the vehicle first to view notifications.
- 3 The list of menu items appears.
 - **Display Off:** Turns off the screen. To switch the screen back on, press the screen or briefly press the power button.
 - **Show Notification Popup:** Set to display notifications upon receipt in a pop-up.
 - **User's Manual on Web (QR Code):** Displays the QR code that provides access to the online user manual for the system.
 - **Split Screen:** Can turn on or off the split screen mode.

Using the Valet mode (if equipped)

Use the Valet mode to protect your personal information and view the vehicle information.



Valet mode protects your personal information by disabling control using the screen or buttons. Vehicle information created during valet mode can be viewed from the Bluelink App.

The following vehicle-related data can be viewed from the Bluelink App.

- Valet mode start time
- Engine off time
- Driving distance/hours and maximum vehicle speed after valet mode activation

 To use Valet mode, make sure you install the Bluelink App on your smartphone and sign up for the Bluelink Service. Use either Google Play Store or App Store (depending on your smartphone model) to download and install the Bluelink App and sign up for the Bluelink Service. ▶ See "Subscribing to the service."

1 On the All Menus screen, press **Valet Mode**.

 To access the online user's manual on the Valet Mode screen, press  ▶ **User's Manual on Web (QR Code)** and then scan the displayed QR code.

2 Enter a password to turn on the valet mode.

Your personal information is protected, as control using the screen or buttons is disabled.

 To turn off valet mode, enter the password you set when turning on the mode.

 It is not possible to turn off Valet mode if you enter your password incorrectly five times in succession. If this occurs and you want to turn off Valet mode, use the Bluelink App to reset your Valet mode password. Alternatively, contact the Hyundai Customer Relations Center 1-844-258-5656 for assistance.

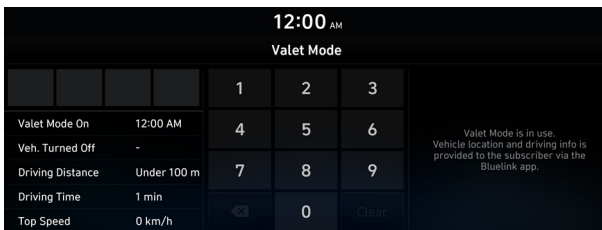

The screenshot shows the Valet Mode interface. At the top, the time is 12:00 AM. Below the time, the text "Valet Mode" is displayed. A numeric keypad is visible, with digits 1 through 9 and 0. To the left of the keypad, there is a table of vehicle information. To the right, there is a warning message.

		1	2	3
Valet Mode On	12:00 AM	4	5	6
Veh. Turned Off	-	7	8	9
Driving Distance	Under 100 m		0	Clear
Driving Time	1 min			
Top Speed	0 km/h			

Valet Mode is in use.
Vehicle location and driving info is provided to the subscriber via the Bluelink app.

Using N mode (if equipped)

Set the vehicle system for high-performance driving. You can configure drive mode and performance options for optimal driving and view real-time information.

 **N Mode** settings can be changed only when the vehicle is on.

On the All Menus screen, press **N Mode**.

N mode screen

The N mode screen provides the following features and information:



- 1 Returns to the previous step.
- 2 Displays the vehicle engine oil temperature, coolant temperature and torque in real time.
- 3 Displays the vehicle speed and gear position in real time.
- 4 Displays the lap time.
- 5 Provides information on the current circuit. (If circuit information is not available, a circuit graphic or custom widget is provided.)

- ⑥ Displays the Brake press in real time.
- ⑦ Can select the drive mode for each feature.
- ⑧ Displays the gravitational force generated during a turn in real time.
- ⑨ Can set the RPM to allow for the vehicle to accelerate quickly from a stop.
- ⑩ Set various performance options such as the RPM and drive mode.
- ⑪ The list of menu items appears.
 - **Display Off:** Turns off the screen. To switch the screen back on, press the screen or briefly press the power button.
 - **Edit N Mode Widgets:** Can configure the performance info widget to show on the N mode screen.
 - **Performance Options:** Can select the vehicle's performance options.
 - **Tutorial:** Can view the tutorials on N mode driving such as Track Driving and Economy.
 - **User's Manual on Web (QR Code):** Displays the QR code that provides access to the online user manual for the system.

Configuring the drive mode

You can configure individual settings including the engine and suspension for each drive mode.

- 1 On the All Menus screen, press **N Mode ► CUSTOM**.
- 2 Set up individual settings for each drive mode.

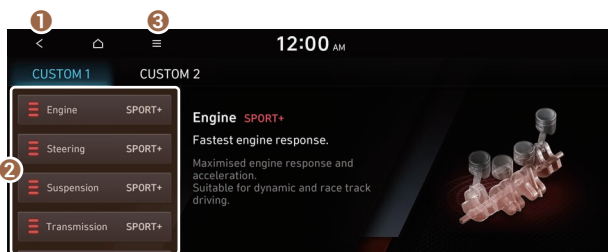

- ① Returns to the previous step.
- ② Can select the drive mode for each feature.
 - **Engine:** Can select the engine operation mode.
 - **Steering:** Can change the steering setting. This setting determines the steering experience.
 - **Suspension:** Can change the suspension system setting. This setting determines the ride experience.

- **Transmission:** Can change the transmission setting. The transmission setting determines the shifting speed and damping level.
 - **ESC:** Can set the ESC sensitivity. This setting determines the degree of automatic control the system performs to maintain stability.
 - **Rev Matching:** Rev Matching allows shifting without depressing the accelerator.
 - **e-LSD:** Can set differential control of the wheels. e-LSD improves steering performance during a turn while preventing a slip.
 - **Exhaust Sound:** Can select the exhaust sound for driving.
 - **Head-Up Display:** You can set to use the head-up display that displays information such as driving speed and road-related information while driving.
- ③ The list of menu items appears.
- **Display Off:** Turns off the screen. To switch the screen back on, press the screen or briefly press the power button.
 - **Reset:** Can reset all settings.

Managing driving records

You can check the lap time records and measure the acceleration performance.

Checking a lap time records

You can view lap time records including the history and the best time.

On the All Menus screen, press **N Mode ▶ Lap Timer ▶ Lap**.

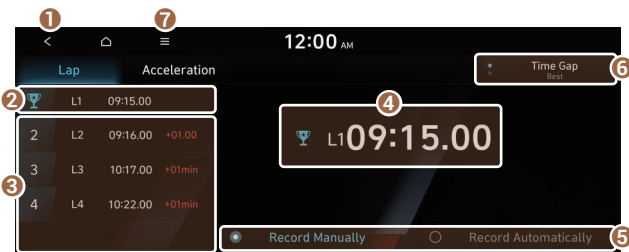

- ① Returns to the previous step.
- ② Displays the best lap time.
- ③ Displays the last lap time.
- ④ Displays the current lap time.
- ⑤ Select whether to measure lap time records automatically or manually.

- ⑥ Can set the base record to show the time gap from the best or last lap.
- ⑦ The list of menu items appears.
 - **Display Off:** Turns off the screen. To switch the screen back on, press the screen or briefly press the power button.
 - **Lap List:** Displays the previous records in detail.

Measuring acceleration time

You can measure how long the vehicle takes to reach the target speed from a stop.

On the All Menus screen, press **N Mode** ► **Lap Timer** ► **Acceleration**.

⚠ Caution

- You must be in an environment where you can drive and measure the time safely.
- If you are on a public road, make sure you are following all relevant traffic regulations.

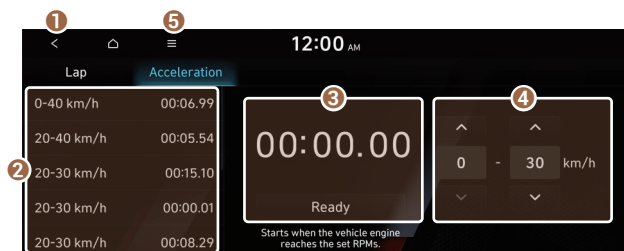

- ① Returns to the previous step.
- ② Shows the measurement.
- ③ Can start or cancel the measurement. Press the button and depress the accelerator to start.
- ④ Can set the start and target speeds.
- ⑤ The list of menu items appears.
 - **Display Off:** Turns off the screen. To switch the screen back on, press the screen or briefly press the power button.
 - **Acceleration List:** Displays the previous records in detail.
 - **Reset:** Delete all records.

Viewing driving performance information

You can view real-time information on your vehicle's driving performance, such as the gravitational force or the turbo boost pressure.

- 1 On the All Menus screen, press **N Mode**.
- 2 In the N mode screen, select an item you want to view.
Detailed performance information will be provided.



- **Throttle:** Displays the throttle gauge in real time.
- **Oil Temp.:** Displays the engine oil temperature in real time.
- **Engine Temp.:** Displays the coolant temperature in real time.
- **Speed:** Displays the current vehicle speed in real time.
- **Brake Press:** Displays the Brake press in real time.
- **Power:** Displays the engine power in real time.
- **Torque:** Displays the engine torque in real time.
- **Turbo:** Displays the engine turbo boost pressure in real time.

Setting performance options

Set various performance options such as the RPM and drive mode.

- 1 On the All Menus screen, press **N Mode ► Performance Options**.
- 2 Select the performance option menu you want to set.

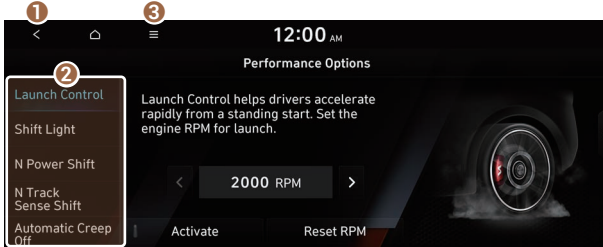

- 1 Returns to the previous step.
- 2 Can select the vehicle's performance options.
 - **Launch Control:** Can set the RPM to allow for the vehicle to accelerate quickly from a stop.
 - **Shift Light:** Can set the drive mode and RPM for displaying the shifting signal.
 - **N Power Shift:** Reduces jerking when shifting and improves acceleration performance by optimizing the shifting response (if equipped).
✎ Only available in N mode or **SPORT+** under CUSTOM Mode.
 - **N Track Sense Shift:** Can set to automatically change the shifting mode for Track Driving when detecting dynamic driving conditions (if equipped).
✎ Only available in N mode or **SPORT+** under CUSTOM Mode.
 - **N Road Sense:** Recommendation to switch to N mode, when a S-bend sign is sensed.
 - **Automatic Creep Off:** Prevents the vehicle from automatically launching even when the brake is released while stopped in D position.
 - **Active Sound Design:** Adjust the interior engine sound volume.
- 3 The list of menu items appears.
 - **User's Manual on Web (QR Code):** Displays the QR code that provides access to the online user manual for the system.
 - **Split Screen:** Can turn on or off the split screen mode.

03

Radio

Turning on the radio
Listening to HD Radio™
Listening to SiriusXM™ radio

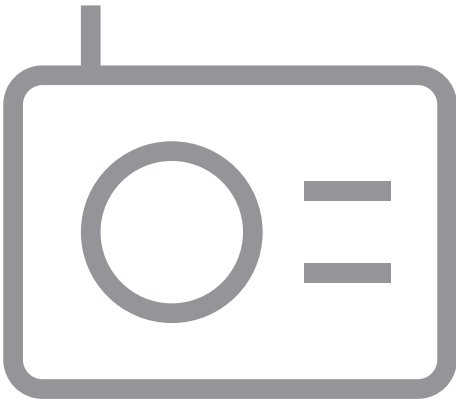

Turning on the radio

You can scan radio channels by using various options. Save your favorite channels to the presets list.

Perform any of the following methods:

- On the All Menus screen, press **Radio**.
 - On the control panel, press the [**RADIO**] button (if equipped).
- ✎ When multiple media are connected, press the [**RADIO**] or [**MEDIA**] button once more and then press the desired media source from the Radio/Media selection window (if equipped).



Type1



Type2

- ✎ The displayed screen or menu items may differ, depending on the vehicle model and features. Check the screen type for your vehicle model and view the appropriate instructions.

Radio screen (Type1)

The radio screen provides various functions while listening to radio broadcasts.



- 1 Returns to the previous step.
- 2 Can change the radio mode.
- 3 Activate the HD Radio mode.
- 4 You can change radio channels by using voice commands. ▶ See "Changing the channel by using voice commands."
- 5 Presets list
- 6 Radio broadcast information
- 7 You can delete or save the current frequency to the presets list. ▶ See "Saving radio channels (Type1)."
- 8 Can turn on or off the split screen mode.
- 9 You can listen to each radio channel for a short time and select the desired channel.
▶ See "Using the scan function."
- 10 Can change the frequency. Shortly press to switch to the previous/next frequency, or press and hold to quickly change the frequency. When you release the ◀ or ▶ button, the previous or next channel with good reception is automatically selected (if equipped).
- 11 The list of menu items appears.
 - **Enter Station:** Can select or directly enter the desired radio frequency.
 - **Station List:** Can see the list of available radio stations.
 - **FM Radio Noise Control:** Customize sound quality when listening to FM radio by adjusting background noise of the original sound (if equipped).
 - **Info:** Turns the Radio text information transmitted from the broadcasting station on and off.
 - **Delete Presets:** Can delete a registered channel from the presets list. ▶ See "Deleting a registered channel."

- **Sound Settings:** Displays the system sound settings screen. ► See "Configuring the sound settings (Type1)."
- **User's Manual on Web (QR Code):** Displays the QR code that provides access to the online user manual for the system.
- **Split Screen:** Can turn on or off the split screen mode.

 The screen may differ depending on the vehicle model and specifications.



Warning

Driving while distracted can result in a loss of vehicle control that may lead to an accident, severe bodily injury, or death. The driver's primary responsibility is the safe and legal operation of the vehicle, and the use of any vehicle systems, including the touch screen and steering wheel controls, which take the driver's eyes, attention, and focus away from the safe operation of the vehicle, or which are not permissible by law, should never be used during the operation of the vehicle.

Radio screen (Type2)

The radio screen provides various functions while listening to radio broadcasts.



- 1 Returns to the previous step.
- 2 Radio broadcast information
- 3 Can change the radio mode.
- 4 Can change the frequency. Shortly press to switch to the previous/next frequency, or press and hold to quickly change the frequency. When you release the  or  button, the previous or next channel with good reception is automatically selected.
- 5 Shows information about the radio channel you are currently tuned in to.
- 6 Activate the HD Radio mode.
- 7 You can delete or save the current frequency to the presets list. ► See "Saving radio channels (Type2)."

- 8 Can turn on or off the split screen mode.
- 9 Presets list
- 10 Can see the list of available radio stations (if equipped).
- 11 You can change radio channels by using voice commands. ► See "Changing the channel by using voice commands."
- 12 The list of menu items appears.
 - **Display Off:** Turns off the screen. To switch the screen back on, press the screen or briefly press the power button.
 - **Enter Station:** Can select or directly enter the desired radio frequency.
 - **Station List:** Can see the list of available radio stations.
 - **Scan FM** (Available only with FM): Select a broadcast of your choice after listening briefly to broadcasts from different radio stations.
 - **Scan AM** (Available only with AM): Select a broadcast of your choice after listening briefly to broadcasts from different radio stations.
 - **Delete Presets:** Can delete a registered channel from the presets list. ► See "Deleting a registered channel."
 - **Info:** Turns the Radio text information transmitted from the broadcasting station on and off.
 - **Radio Noise** (Available only with FM):Customize sound quality when listening to FM radio by adjusting background noise of the original sound (if equipped).
 - **Sound Settings:** Displays the system sound settings screen. ► See "Configuring the sound settings (Type2)."
 - **User's Manual on Web (QR Code):** Displays the QR code that provides access to the online user manual for the system.
 - **Split Screen:** Can turn on or off the split screen mode.

 The screen may differ depending on the vehicle model and specifications.

 The sound effect settings button may appear on the screen depending on the amp specifications.

Warning

Driving while distracted can result in a loss of vehicle control that may lead to an accident, severe bodily injury, or death. The driver's primary responsibility is the safe and legal operation of the vehicle, and the use of any vehicle systems, including the touch screen and steering wheel controls, which take the driver's eyes, attention, and focus away from the safe operation of the vehicle, or which are not permissible by law, should never be used during the operation of the vehicle.

Changing the radio mode (Type1)

Perform any of the following methods:

- On the **Radio** screen, press **Band**.
- On the control panel, press the [**RADIO**] button repeatedly.



 The screen may differ depending on the vehicle model and specifications.

Changing the radio mode (Type2)

Perform any of the following methods:

- On the **Radio** screen, press Radio Mode button repeatedly.
- On the control panel, press the [**RADIO**] button repeatedly (if equipped).

The radio mode changes in the order of **FM ► AM ► SXM**.



 The screen may differ depending on the vehicle model and specifications.

Changing the radio channel (Type1)

Perform any of the following methods:

- On the **Radio** screen, press the desired channel from the presets list.
 - ✍ You can also change the channel by using the Move lever/button on the steering wheel.
- On the control panel, press the [**SEEK**] or [**TRACK >**] button. You can move to the previous or next channel with good reception.

You can listen to the changed radio broadcast.

✍ If any Search knob on the control panel, you can also change the frequency by using the knob.

Changing the channel by using voice commands

You can change the radio channel by using voice commands.

- 1 On the **Radio** screen, press .
- 2 When a guiding beep is heard, say the desired radio station channel.

Using the scan function

You can listen to each broadcast briefly and select a desired one.

- 1 On the **Radio** screen, press .
- Only the channels with good reception can be listened for 5 seconds in turn.



✍ The screen may differ depending on the vehicle model and specifications.

- 2 When you find the desired broadcast, press .
- You can continue listening to the scanned channel.

Changing the radio channel (Type2)

Perform any of the following methods:

- On the **Radio** screen, press the desired channel from the presets list.
 - ✍ You can also change the channel by using the Move lever/button on the steering wheel.
- On the control panel, press the [**< SEEK**] or [**TRACK >**] button. You can move to the previous or next channel with good reception (if equipped).

You can listen to the changed radio broadcast.

✍ If any Search lever/knob on the control panel, you can also change the frequency by using the lever/knob.

Changing the channel by using voice commands

You can change the radio channel by using voice commands.

- 1 On the **Radio** screen, press .
- 2 When a guiding beep is heard, say the desired radio station channel.

Using the scan function

You can listen to each broadcast briefly and select a desired one.

- 1 On the **Radio** screen, press  **▶ Scan FM/Scan AM.**
Only the channels with good reception can be listened for 5 seconds in turn.
- 2 When you find the desired broadcast, press the radio screen.
You can continue listening to the scanned channel.

Saving radio channels (Type1)

You can save a specific radio station's channel and easily access the channel.

While listening to a broadcast, press  in the middle of the screen.

The current channel is added to the presets list.

 Alternatively, on the **Radio** screen, press **Menu** ► **Station List** and press  of the channel you want to save. The channel is saved to the preset list.

 You can register up to 40 channels.

 The screen may differ depending on the vehicle model and specifications.



Saving radio channels (Type2)

You can save a specific radio station's channel and easily access the channel.

While listening to a broadcast, press  on the screen.

The current channel is added to the presets list.

 Alternatively, on the **Radio** screen, press  ► **Station List** and press  of the channel you want to save. The channel is saved to the preset list.

 You can register up to 24 channels.



 The screen may differ depending on the vehicle model and specifications.

Editing the radio channel list (Type1)

Deleting a registered channel

1 At the upper left of the **Radio** screen, press **Menu ► Delete Presets**.

2 Select the channel to delete and press **Delete ► Yes**.

The channel is deleted and the preset number is emptied.

 When the current channel is already assigned to the presets list, press the  icon to remove the channel from the list.

Editing the radio channel list (Type2)

Deleting a registered channel

1 At the upper left of the **Radio** screen, press  ► **Delete Presets**.

2 Select the channel to delete and press **Delete ► Yes**.

The channel is deleted and the preset list is emptied.

 When the current channel is already assigned to the presets list, press  to remove the channel from the list.

Listening to HD Radio™

You can listen to radio from HD radio stations when they are available.

Perform any of the following methods:

- Type 1: On the **Radio** screen, press **HD Radio**.
- Type 2: On the **Radio** screen, press .

When HD Radio signals are received, the radio switches from the analog mode to the HD mode.



Type1



Type2

- ✍ The screen may differ depending on the vehicle model and specifications.
- ✍ In HD mode, the buttons for HD Radio stations appear at the top of the radio screen. Press a button to select any available HD radio station.
- ✍ HD radio is available only in metropolitan areas.

HD Radio™ Technology



Program Info

Program Info: Presents song name, artist, station IDs, and other relevant data streams.

Digital Sound

Digital, CD-quality sound. HD Radio™ Technology enables local radio stations to broadcast a clean digital signal. AM sounds like today's FM and FM sounds like a CD.

HD2/HD3

FM stations can provide additional digital-only audio programming on HD2/HD3 Channels.

Traffic

Real-Time Traffic reports, alerts, and flow data displayed on screen via interactive traffic maps and/or data.

Listening to SiriusXM™ radio

You can listen to radio channels provided by SiriusXM, a satellite radio service.

Changing to SiriusXM mode (Type1)

On the **Radio** screen, press **Band** ► **SiriusXM**.



✍ The screen may differ depending on the vehicle model and specifications.

SiriusXM mode screen

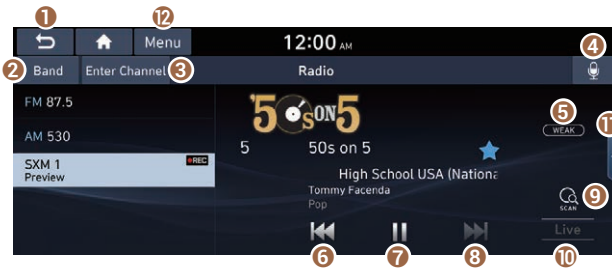

- 1 Returns to the previous step.
- 2 Can change the radio mode.
- 3 Can enter channel number to select the channel directly.
- 4 You can change radio channels by using voice commands. ► See "Changing the channel by using voice commands."
- 5 The indicator turns on when signal reception is weak.
- 6 Moves to the previous segment. Press and hold to rewind the broadcast.
- 7 Pauses or restarts the broadcast.
- 8 Moves to the next segment. Press and hold to fast-forward the broadcast.
- 9 Scans through all available SiriusXM radio channels.

- 10 Switches to live broadcast mode. This button is activated when you have moved to the previous segment while listening to a live broadcast.
- 11 Can turn on or off the split screen mode.
- 12 Displays the options list.
 - **Channel List:** Can see the list of available SiriusXM channels.
 - **What is on My Presets?:** Displays the broadcast schedule.
 - **Featured Favorites:** Can listen to groups of channels provided by SiriusXM.
 - **Delete Presets:** Can delete a registered channel from the presets list.
 - **Sound Settings:** Displays the system sound settings screen.
 - **User's Manual on Web (QR Code):** Displays the QR code that provides access to the online user manual for the system.
 - **Split Screen:** Can turn on or off the split screen mode.

 The **REC** icon appears next to the first 10 SiriusXM channels saved. Once preset channels have been saved, the broadcasts from them are buffered automatically for your convenience each time you start the vehicle.

Changing to SiriusXM mode (Type2)

On the **Radio** screen, press Radio Mode button repeatedly.



 The screen may differ depending on the vehicle model and specifications.

SiriusXM mode screen

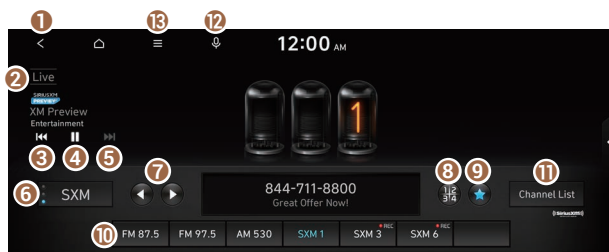

- ❶ Returns to the previous step.
- ❷ Switches to live broadcast mode. This button is activated when you have moved to the previous segment while listening to a live broadcast.
- ❸ Moves to the previous segment. Press and hold to rewind the broadcast.
- ❹ Pauses or restarts the broadcast.
- ❺ Moves to the next segment. Press and hold to fast-forward the broadcast.
- ❻ Can change the radio mode.
- ❼ You can go to the previous or next channel.
- ❽ Can enter channel number to select the channel directly.
- ❾ You can delete or save the current frequency to the presets list.
- ❿ Presets list
- ⓫ Can see the list of available SiriusXM channels (if equipped).
- ⓬ You can change radio channels by using voice commands. ▶ See "Changing the channel by using voice commands."
- ⓭ Displays the options list.
 - **Display Off:** Turns off the screen. To switch the screen back on, press the screen or briefly press the power button.
 - **Channel List:** Can see the list of available SiriusXM channels.
 - **Scan SXM Channels:** Scan and play each SiriusXM channel for 5 seconds.
 - **Delete Presets:** Can delete a registered channel from the presets list.
 - **What is on My Presets?:** Displays the broadcast schedule.
 - **Featured Favorites:** Can listen to groups of channels provided by SiriusXM.
 - **Sound Settings:** Displays the system sound settings screen.
 - **User's Manual on Web (QR Code):** Displays the QR code that provides access to the online user manual for the system.
 - **Split Screen:** Can turn on or off the split screen mode.

✍ The screen may differ depending on the vehicle model and specifications.

✍ The  icon appears next to the first 10 SiriusXM channels saved. Once preset channels have been saved, the broadcasts from them are buffered automatically for your convenience each time you start the vehicle.

Searching for SiriusXM radio channels (Type1)

You can select a channel from available SiriusXM channels.

- 1 On the **Radio** screen, press **Band** ► **SiriusXM**.
- 2 On the SiriusXM radio screen, press **Menu** ► **Channel List**.
- 3 Select a category and a channel.

- ✍ To skip a channel when scanning with the [**< SEEK**] or [**TRACK >**] button, press **Skip**.
- ✍ If there is a Search knob on the control panel, you can also scan for channels by using the knob.
- ✍ The current channel is added to the presets list when pressing .

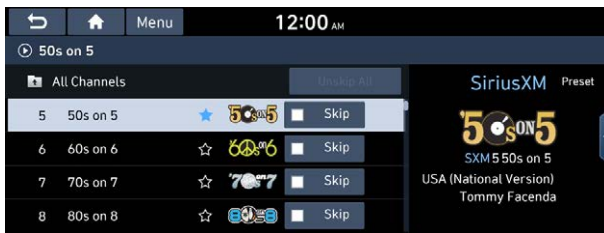

Searching for SiriusXM radio channels (Type2)

You can select a channel from available SiriusXM channels.

- 1 On the **Radio** screen, press Radio Mode button repeatedly.
- 2 On the SiriusXM radio screen, press  ► **Channel List**.
- 3 Select a category and a channel.

- ✍ To skip a channel when scanning with the [**< SEEK**] or [**TRACK >**] button, press **Skip** (if equipped).
- ✍ Press the  broadcasts from the channels are buffered automatically each time you start the vehicle. Accordingly, you can perform channel scan while listening (if equipped).

- ✎ If there is a Search lever/knob on the control panel, you can also scan for channels by using the knob.
- ✎ The current channel is added to the presets list when pressing .

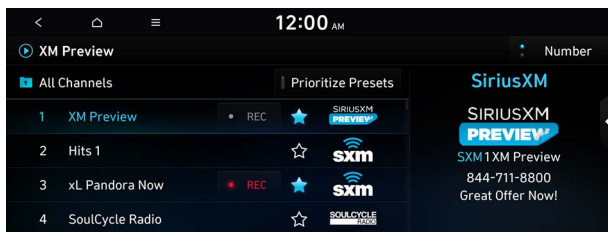

Selecting a channel by entering a channel number (Type1)

When you know the exact channel number, you can enter it to select the channel directly.

- 1 On the **Radio** screen, press **Band** ► **SiriusXM**.
- 2 On the SiriusXM radio screen, press **Enter Channel**.
- 3 Enter a channel number and press **OK**.

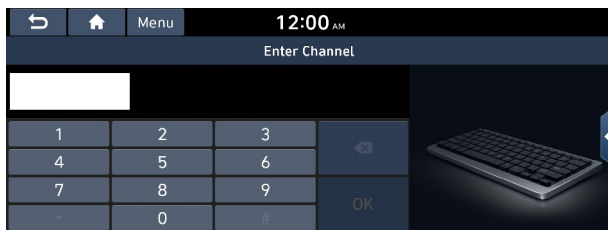

Selecting a channel by entering a channel number (Type2)

When you know the exact channel number, you can enter it to select the channel directly.

- 1 On the **Radio** screen, press Radio Mode button repeatedly.
- 2 On the SiriusXM radio screen, press .
- 3 Enter a channel number and press **OK**.

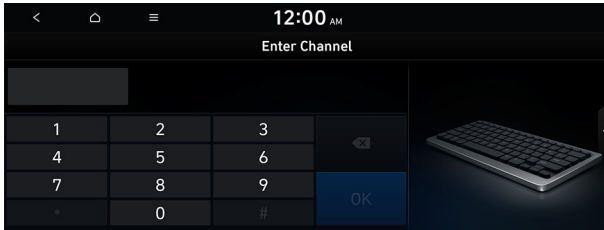

Viewing the program schedule (Type1)

You can see the program schedule and information for the channels saved in your preset list.

- 1 On the **Radio** screen, press **Band** ► **SiriusXM**.
- 2 On the SiriusXM radio screen, press **Menu** ► **What is on My Presets?**
- 3 Set the date and time on the top line of the screen.

 To select a date, press the date display field at the top left of the preset list and select the date and time zone.

 To select a time, press  or .

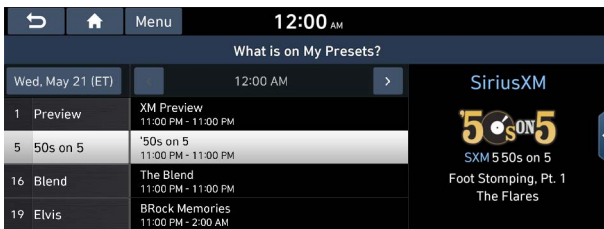

- 4 Select a channel and a program to see its detailed information.

 If any hidden information, an arrow appears next to the program. Press the arrow to see the hidden information.

Viewing the program schedule (Type2)

You can see the program schedule and information for the channels saved in your preset list.

- 1 On the **Radio** screen, press Radio Mode button repeatedly.
- 2 On the SiriusXM radio screen, press **☰ ▶ What is on My Presets?**.
- 3 Set the date and time on the top line of the screen.

✎ To select a date, press the date display field at the top left of the preset list and select the date and time zone.

✎ To select a time, press **◀** or **▶**.

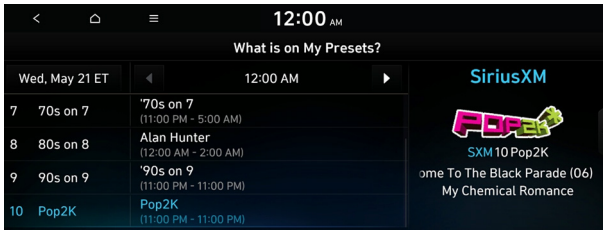

- 4 Select a channel and a program to see its detailed information.

✎ If any hidden information, an arrow appears next to the program. Press the arrow to see the hidden information.

Listening to Featured Favorite channels (Type1)

You can listen to Featured Favorites channels on the SiriusXM radio. Multiple sets of channels can be broadcast and can be changed by SiriusXM.

- 1 On the **Radio** screen, press **Band ▶ SiriusXM**.
- 2 On the SiriusXM radio screen, press **Menu ▶ Featured Favorites**.
- 3 Select a channel.

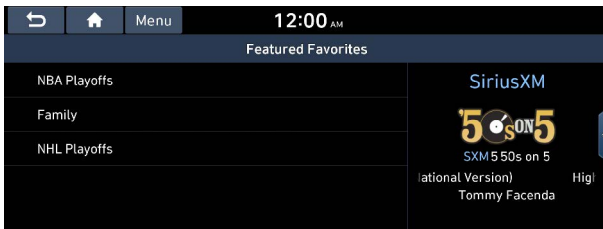

Listening to Featured Favorite channels (Type2)

You can listen to Featured Favorites channels on the SiriusXM radio. Multiple sets of channels can be broadcast and can be changed by SiriusXM.

- 1 On the **Radio** screen, press Radio Mode button repeatedly.
- 2 On the SiriusXM radio screen, press  **▶ Featured Favorites**.
- 3 Select a channel.

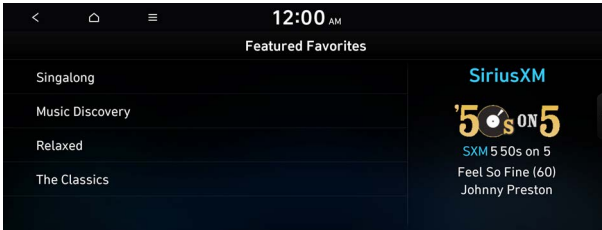

04

Media

Using media

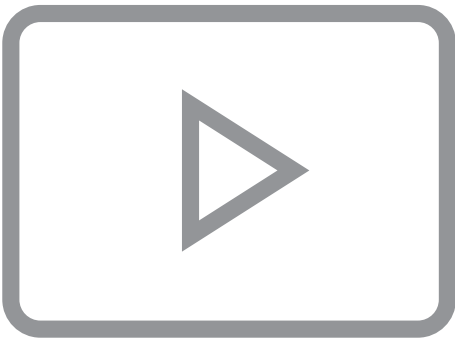

Using media

You can use the USB mode to play music files on a connected mobile device, such as USB device and MP3 player. You can also play Bluetooth music by connecting a Bluetooth device, which supports a Bluetooth function.

Playing music from a USB device

1 Connect a media device to play to the USB port on the vehicle.

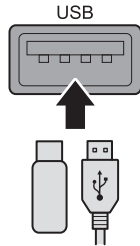

- ✍ Playback may start automatically depending on the media type.
- ✍ For more information about supportable devices and file types: ► see "USB mode."
- ✍ The shapes and arrangement of the buttons and USB port may differ depending on the vehicle model and specifications.

2 Perform any of the following methods:

- On the Home screen, press the Radio/Media info widget or on the All Menus screen, press **Media**.
- On the control panel, press the **[MEDIA]** button.
- ✍ When multiple media are connected, press the **[RADIO]** or **[MEDIA]** button once more and then press the desired media source from the Radio/Media selection window (if equipped).

USB music screen

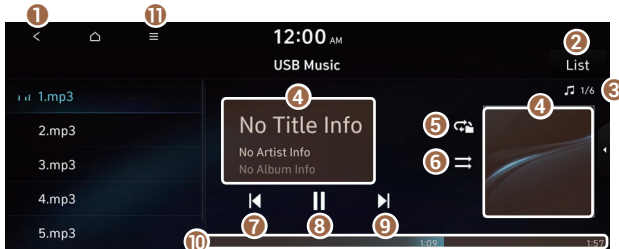

- ① Returns to the previous step.
- ② Moves to the file list screen.
- ③ Displays the sequence number of the current file and the total number of files for playback.
- ④ Displays the information of the current music. Press the artist or album info of the current song to go to list of songs by the artist or from the album.
- ⑤ Used to change the repeat playback mode.
- ⑥ Used to turn on or off the shuffle playback mode.
- ⑦ Restart playing the current file or previous file.
- ⑧ Can pause or resume playback.
- ⑨ Can play the next file.
- ⑩ Can see the duration of the playing song and the current playback position.
- ⑪ The list of menu items appears.
 - **Display Off:** Turns off the screen. To switch the screen back on, press the screen or briefly press the power button.
 - **Media Sources:** Opens the Radio/Media selection window.
 - **Songs by this Artist:** Moves to the list of the artist's songs.
 - **Songs from this Album:** Moves to the list of music albums that contain the current song.
 - **Hide Current File:** You can hide the file that is playing.
 - **Sound Settings:** Displays the system sound settings screen.
 - **User's Manual on Web (QR Code):** Displays the QR code that provides access to the online user manual for the system.
 - **Split Screen:** Can turn on or off the split screen mode.

 The sound effect settings button may appear on the screen depending on the amp specifications.

Warning

Driving while distracted can result in a loss of vehicle control that may lead to an accident, severe bodily injury, or death. The driver's primary responsibility is the safe and legal operation of the vehicle, and the use of any vehicle systems, including the touch screen and steering wheel controls, which take the driver's eyes, attention, and focus away from the safe operation of the vehicle, or which are not permissible by law, should never be used during the operation of the vehicle.

Pause/Resume

You can pause or resume playback of a USB music file.

On the USB music playback screen, press  or .

Rewind

By using the rewind function, you can listen to music in the USB device from the desired point during playback.

Perform any of the following methods:

- On the USB music playback screen, press and hold .
- On the control panel, press and hold the [**< SEEK**] button (if equipped).

 You can also run the function by using the Move lever/button on the steering wheel.

Fast forward

By using the fast forward function, you can listen to music in the USB device from the desired point during playback.

Perform any of the following methods:

- On the USB music playback screen, press and hold .
- On the control panel, press and hold the [**TRACK >**] button (if equipped).

 You can also run the function by using the Move lever/button on the steering wheel.

Resuming playback of the current music

You can play the current music in the USB device from the beginning.

Perform any of the following methods:





- On the USB music playback screen, press  after 3 seconds during playback.
- On the control panel, press the [**< SEEK**] button after 3 seconds during playback (if equipped).

 You can also run the function by using the Move lever/button on the steering wheel.

Playing the previous file

You can play the previous file during playback in the USB device.



Perform any of the following methods:

- On the USB music playback screen, press  within 3 seconds during playback.
 - On the control panel, press the [**< SEEK**] button within 3 seconds during playback (if equipped).
-  To play the previous music during playback, press  twice or pressing the [**< SEEK**] button on the control panel twice after 3 seconds from the start of the playback (if equipped).
-  You can also run the function by using the Move lever/button on the steering wheel.
-  If any Search lever/knob on the control panel, you can search for the desired music by using the lever/knob. When you press the lever/knob within 5 seconds, music is played. However, if no input within 5 seconds, the search stops and the system displays the information of the current file.

Playing the next file

You can play the next file in the USB device during playback.

Perform any of the following methods:

- On the USB music playback screen, press .
 - On the control panel, press the [**TRACK >**] button (if equipped).
-  You can also run the function by using the Move lever/button on the steering wheel.
-  If any Search lever/knob on the control panel, you can search for the desired music by using the lever/knob. When you press the lever/knob within 5 seconds, music is played. However, if no input within 5 seconds, the search stops and the system displays the information of the current file.

Changing the repeated playback mode for USB music

You can change the repeated playback mode for USB music: Repeat One, Repeat Folder, and Repeat All.

On the USB music playback screen, press  repeatedly.

Each time the icon is pressed, the playback repetition modes are toggled and the activated mode icon appears on the screen.

Turning on/off the shuffle playback mode for USB music

You can turn on or off the shuffle playback mode for USB music.

On the USB music playback screen, press  repeatedly.

Each time the icon is pressed, the shuffle playback mode is turned on and off. When the shuffle playback is active, the files are played randomly with no sequence.

USB music list screen

You can search and play the desired music from the list by pressing **List** on the USB music playback screen.

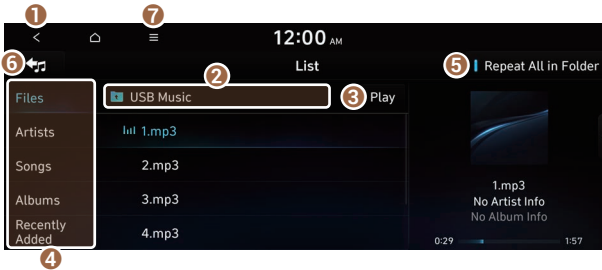

- 1 Returns to the previous step.
- 2 Moves to the upper folder or category.
- 3 Play all songs in this category.
- 4 Can see music files for each category. In the artist or album category, you can select multiple artists or albums to play their songs.
- 5 Set to play media files in all sub-folders included in the current playlist.
- 6 Return to the playback screen (if equipped).
- 7 The list of menu items appears.
 - **Display Off:** Turns off the screen. To switch the screen back on, press the screen or briefly press the power button.
 - **Media Sources:** Opens the Radio/Media selection window.
 - **Now Playing:** You can return to the folder of the playing file while searching in the list.
 - **Split Screen:** Can turn on or off the split screen mode.

 The sound effect settings button may appear on the screen depending on the amp specifications.

Caution

- Be sure to start the vehicle before connecting a USB device. When you start the vehicle after connecting a USB device, the USB device may get damaged.
- Be careful of static electricity when connecting or removing a USB device. It may cause a system failure.
- Be careful and avoid your body or any object coming into contact with the USB port on the vehicle. It may cause an accident or system failures.
- Do not repeatedly connect and remove the USB connector within a short time. It may cause device errors or system failures.
- Do not use a USB device for purposes other than playback. When you connect a USB for charging or heating, the system performance may decrease or it may cause system failures.

- ✍ When connecting a USB storage, do not use a separate extension cable and directly connect to the USB port. When you connect a USB storage via a USB hub or extension cable, the device may not be recognized.
- ✍ Push the USB connector fully into the USB port. When the connector is not fully inserted, a communication problem may occur.
- ✍ Noise may occur when removing a USB device from the system.
- ✍ You can play only the files that have been encoded in the standard format.
- ✍ The following USB devices may not be recognized or may not work properly.
 - Encrypted MP3 players
 - USB devices that are not recognized as removable disks
- ✍ USB devices may not be recognized depending on the device status.
- ✍ Some USB devices may not be supported due to compatibility issues.
- ✍ USB device recognition may take longer than usual depending on the device type, capacity, and file formats on the device.
- ✍ Some devices may not be charged through USB connection. It depends on the USB specifications.
- ✍ You can hide files only in the USB device formatted in exFAT, FAT16/32, or NTFS. The hidden files can be found in the "Hidden_" folder.

Playing music via Bluetooth

To use a Bluetooth device for audio playback, connect a device that supports Bluetooth communication such as mobile phone and MP3 player.

For more information about Bluetooth connection: ► see "[Connecting a Bluetooth device.](#)"

- ✍ The controls or display screens may differ depending on the connected Bluetooth device, phone model, and music player App.
- ✍ The streaming may not be supported in some music player Apps.
- ✍ Some functions may not be available depending on the connected Bluetooth device or phone model.
- ✍ When a media device or mobile phone is connected by both the Bluetooth and USB cable at the same time, the device or system may not work properly. To use the Bluetooth connection, remove all cables from the device.

Bluetooth audio playback screen

The media player runs when you play a music file from a connected audio device via Bluetooth.

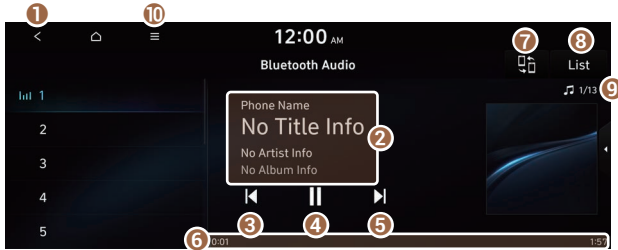

- 1 Returns to the previous step.
- 2 Displays the information of the current music.
- 3 Restart playing the current file or play the previous file.
- 4 Can pause or resume playback.
- 5 Can play the next file.
- 6 Can see the duration of the playing song and the current playback position.
- 7 Find and connect other Bluetooth devices.
- 8 Moves to the music list screen.
 -  The list of Bluetooth audio files may not appear depending on the connected device or app.
- 9 Displays the sequence number of the current file and the total number of files for playback.
- 10 The list of menu items appears.
 - **Display Off:** Turns off the screen. To switch the screen back on, press the screen or briefly press the power button.
 - **Media Sources:** Opens the Radio/Media selection window.
 - **Change Device:** Find and connect other Bluetooth devices.
 - **Sound Settings:** Displays the system sound settings screen.
 - **User's Manual on Web (QR Code):** Displays the QR code that provides access to the online user manual for the system.
 - **Split Screen:** Can turn on or off the split screen mode.

 The screen may differ depending on the vehicle model and specifications.

 The sound effect settings button may appear on the screen depending on the amp specifications.

Pause/Resume

You can pause or resume playback of a Bluetooth audio file.

On the Bluetooth audio playback screen, press  or .

Resuming playback of the current Bluetooth audio file

You can play the current Bluetooth audio file from the beginning.

Perform any of the following methods:

- On the Bluetooth audio playback screen, press .
- On the control panel, press the [**< SEEK**] button (if equipped).

 The actions required may differ depending on the connected device.

 You can also run the function by using the Move lever/button on the steering wheel.

Resuming playback of the previous Bluetooth audio file

You can play the previous Bluetooth audio file during playback.

Perform any of the following methods:

- On the Bluetooth audio playback screen, press  twice.
- On the control panel, press the [**< SEEK**] button twice (if equipped).

 The actions required may differ depending on the connected device.

 You can also run the function by using the Move lever/button on the steering wheel.

 If any Search lever/knob on the control panel, you can search for the desired music by using the lever/knob. When you press the lever/knob within 5 seconds, music is played. However, if no input within 5 seconds, the search stops and the system displays the information of the current file.

Resuming playback of the next Bluetooth audio file

You can play the next Bluetooth audio file during playback.

Perform any of the following methods:

- On the Bluetooth audio playback screen, press .
- On the control panel, press the [**TRACK >**] button (if equipped).

 The actions required may differ depending on the connected device.

 You can also run the function by using the Move lever/button on the steering wheel.

 If any Search lever/knob on the control panel, you can search for the desired music by using the lever/knob. When you press the lever/knob within 5 seconds, music is played. However, if no input within 5 seconds, the search stops and the system displays the information of the current file.

MEMO

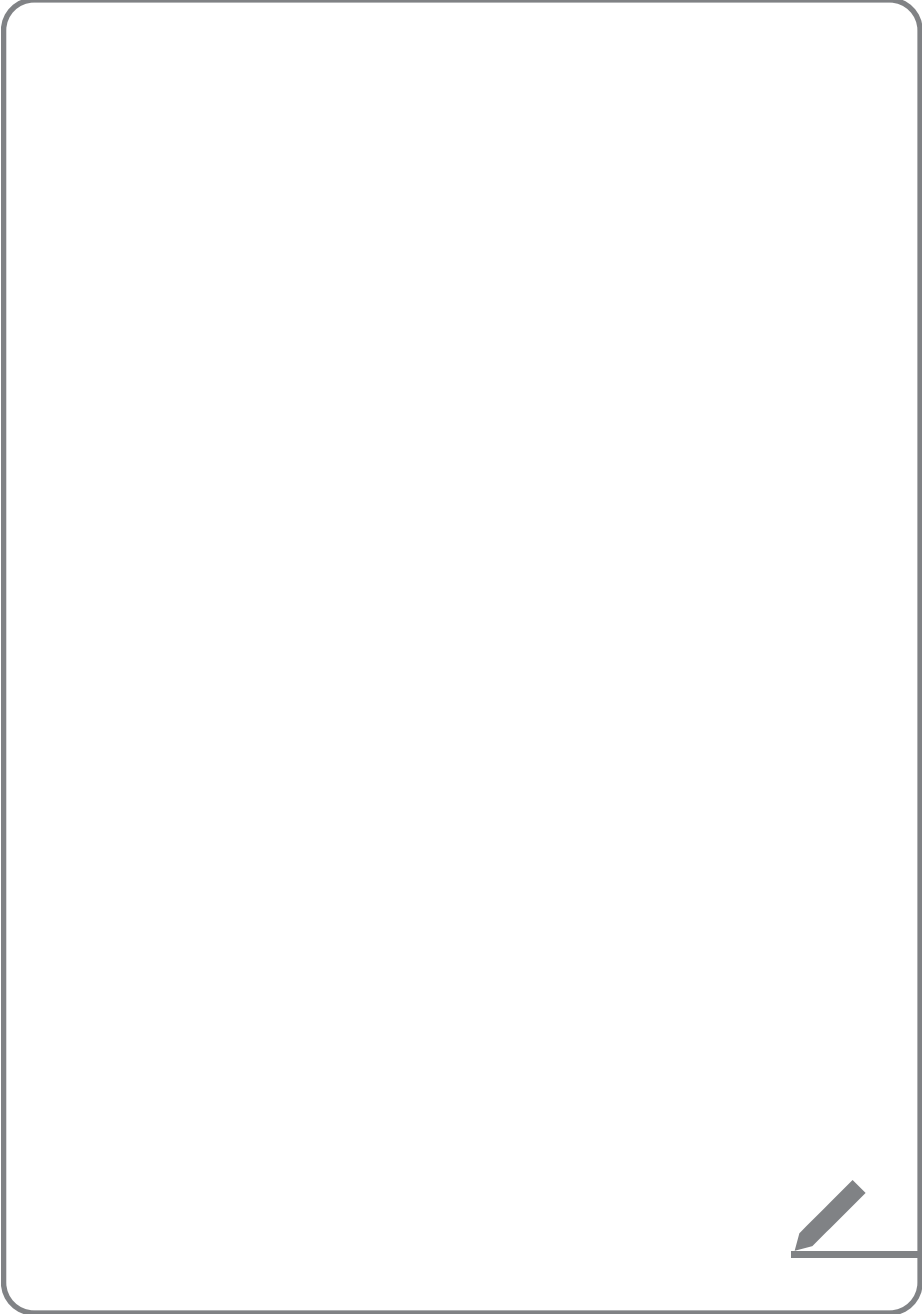

05

Navigation

Navigation functions

Various ways to find routes

Using saved favorite places

Viewing traffic Information

Searching for gas stations

Searching for EV (Electric Vehicle) charging stations

END USER LICENSE AGREEMENT



Navigation functions

Navigation Menu overview

You can use the navigation system conveniently through various functions on the Navigation Menu screen.

Perform any of the following methods:

- On the All Menus screen, press **Navigation Menu**.
- On the control panel, press the **[NAV]** button.



- 1 Returns to the previous step.
- 2 Customize the navigation settings.
- 3 Search for a location by entering various types of keywords such as place name and address. ▶ See "Searching by keyword."
- 4 Search for a location by using the point of interest (POI) categories. ▶ See "Searching for nearby points of interest(POI)."
- 5 Select one of the destinations you entered previously. ▶ See "Searching from previous destinations."
- 6 Select one of the locations stored in your saved places. ▶ See "Using saved favorite places."
- 7 Search for Hyundai Dealerships easily. ▶ See "Searching for Hyundai Dealerships."
- 8 Cancel guidance to the destination. ▶ See "Canceling route guidance."
- 9 View information on the entire route to the destination.
- 10 Edit the waypoints on the way to the destination. ▶ See "Editing the route."
- 11 Reroute by changing the route search option. ▶ See "Changing the route search option."
- 12 You can check accident and construction zone alerts on the map. ▶ See "Viewing traffic Information."

- 13 Register your home, office or other frequently visited places as a favorite location to making searching easier. ▶ See "Saving a frequently visited place as a favorite place."
- 14 The list of menu items appears.
 - **Reorder Icons:** Can change the location of an icon on the Navigation Menu screen.
 - **Display Off:** Turns off the screen. To switch the screen back on, press the screen or briefly press the power button.
 - **User's Manual on Web (QR Code):** Displays the QR code that provides access to the online user manual for the system.

✎ Available icons and their arrangement may differ depending on the vehicle model and specifications.

Finding a route easily

Warning

Driving while distracted may cause a loss of vehicle control that may lead to an accident, severe bodily injury, or death. The driver's primary responsibility is the safe and legal operation of the vehicle, and the use of any devices or systems that take the driver's attention away from driving.

1 Perform any of the following methods:

- On the All Menus screen, press **Navigation Menu ▶ Search**.
- On the map screen, press .

✎ Press and hold the [NAV] button on the control panel to enter into Places.

2 Enter the location data such as place name, address, or coordinates and then press **OK**.

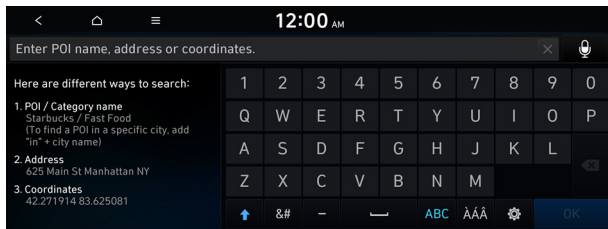

3 Select a destination from the search result.

- ✎ When the communication function is turned on, online search is performed first.
- ✎ You can see the sites in the list on the preview screen at the right.
- ✎ To sort the search results in a different order, press on the attribute to toggle between options.

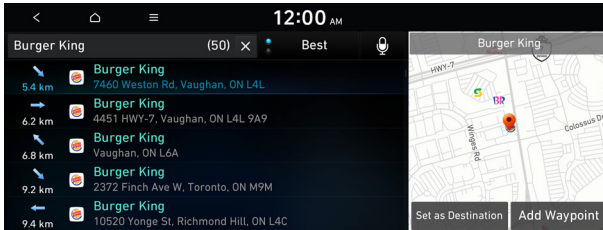

4 Check the location of the destination and then press **Set as Destination**.

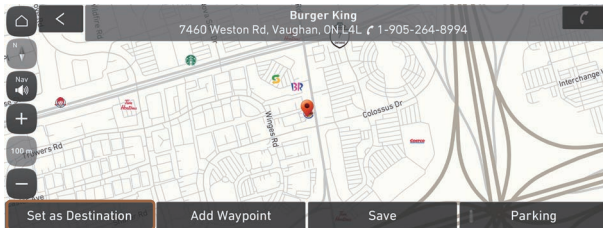

- ✎ If you press **Parking** at the bottom right of the screen, the map screen displays the location icon of the parking lot.

5 Select a route and press **Start Guidance**.

Warning

Distracted driving or negligence in keeping your eyes forward may cause a loss of vehicle control. Never use any devices or systems that take the driver's attention away from driving.

- ✎ The information on the map may differ from actual road conditions, depending on the location or driving conditions.
 - Digitalized roads may not be identical to the actual roads. When guidance does not match the actual route, drive the vehicle according to actual road conditions.
 - The system may provide guidance that differs from the actual route due to a change in road conditions. When guidance does not match the actual route, drive the vehicle according to road conditions with observing the traffic regulations. When the vehicle reaches a zone that matches the actual route, the system guides the route correctly.

✎ Vehicle location may not be displayed correctly if:

- The vehicle is driving on a Y-shaped or winding road with narrow angles.
- The vehicle is driving closely to another road.
- The vehicle is driving on a road where there are many tall buildings in the vicinity.
- The vehicle is driving on a new road or a road under construction.
- The vehicle is transported by a ferry or heavy-duty transport vehicle.
- The vehicle is driving in a rugged mountain area or on a steep curve road.
- The vehicle is entering a public road after making a turn through the turntable in an underground parking lot or multi-story parking lot.
- The vehicle stops and starts repeatedly or moves slowly in front of an intersection.
- The system reboots after the vehicle battery has been recharged or replaced.
- The vehicle is driving on a slippery road due to heavy snow, etc.
- The tires have been replaced recently or spare tires (or studless tires) are used.
- Improper-sized tires are used or the pressure of each tire is different.
- The replaced tire is worn out or the studless tires have been used for over two seasons.
- A roof carrier is installed on the vehicle.
- On a highway continued driving causes the system to perform map matching or apply the updated GPS data.

✎ Navigation service may not be provided correctly under the following conditions:

- When the vehicle drives on a straight road continuously, the system may guide you to drive straight. It is not a malfunction.
- Guidance may not be followed immediately after the vehicle makes a turn at an intersection or drives through an intersection.
- The system may guide you to make a U-turn in a prohibited area.
- The system may guide you to a traffic-blocked road (e.g. no-entry road or road under construction).
- The system may guide you to a road away from the destination when there is no road to the destination or there are only narrow roads on the way.
- Guidance may not be proper when the vehicle is off the route.
- Guidance may not match the actual distance on an overpass or underpass due to the difference of the start point.
- When you are driving at high speeds, route recalculations may take longer.

✎ Because the navigation system is used for information purposes only, Hyundai does not assume responsibility of the accuracy of the information.

✎ When the traffic information is not received, the status icon  appears at the top of the map screen.

Map screen

The map screen provides various functions and informations, as follows:



Option A

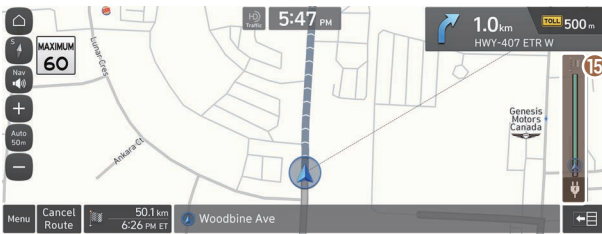

Option B (EV only)

- 1 Displays the Home screen.
- 2 Used to change the map display mode.
 - **(North Up 2D)**: Displays the map with the north fixed at the top.
 - **(Heading Up 2D)**: Rotates the map depending on the travel direction.
 - **(Heading Up 3D)**: Rotates the map depending on the travel direction for 3D view.
- 3 Adjust the navigation sound volume.
- 4 Zooms in the map.
- 5 Set the map scale change mode to automatic or manual.

- ⑥ Zooms out the map.
 - ⑦ Displays the system information on the map. (It can display up to two items.)
 - Traffic information (with an icon if there is no HD data reception)
 - Bluetooth connection status
 - ⑧ Displays the point to change the driving direction.
 - ⑨ Displays the next point to change the driving direction.
 - ⑩ Displays the lanes in different colors.
 - Blue: Recommended lane
 - White: Available lane
 - Gray: Unavailable lane
 - ⑪ Displays quick menu items.
 - ⑫ Stop the navigation guidance. ► See "Canceling route guidance."
 - ⑬ Displays the remaining distance to the destination and the estimated time of arrival. For more details, press the information item.
 - ⑭ Displays or hides the detailed guidance.
 - ⑮ Check the range you can drive with the current amount of battery (EV only).
- ✍ To see only the map with no destination, press the map area on the Home screen or on the All Menus screen, press **Map**. Or press the **[MAP]** button on the control panel.
- ✍ The screen may differ depending on the vehicle model and specifications.

Warning

Be sure to check the road conditions while driving, because the camera information may get changed occasionally after a map update to the latest version. Relying solely on the driving assist system may cause violation of traffic rules and regulations, resulting in an accident.

Using the detailed guidance

When the vehicle needs to change the driving direction or lanes, a zoomed-in map automatically appears.

To display or hide the detailed guidance, press  or .

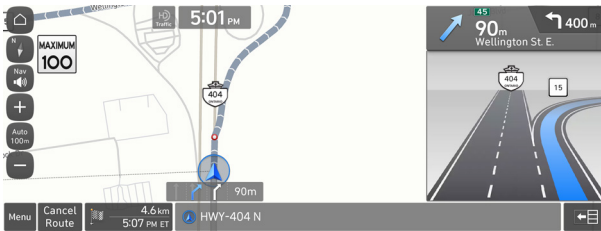

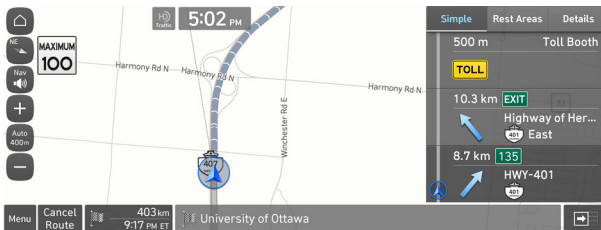

When the detailed guidance appears while driving, select and perform the desired function.

- To view basic information including sections for turns, press **Simple**.
- To check the types of convenience facilities in a rest area, press **Rest Areas**.
- For information details about each zone such as intersections, interchanges, and rest areas, press **Details**.



Adjusting the navigation volume

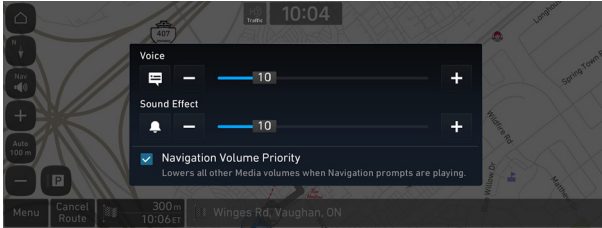

You can adjust the volume of navigation or GPS warning sound.

On the map screen, press  and then press  or , or use the control bar to adjust the volume.



 To have the navigation sound always output first over media sound, check **Navigation Volume Priority**.

 To turn off the navigation voice, press  and then press .

 To turn off the navigation sound effects, press  and then press .

Canceling route guidance

To cancel route guidance, press **Cancel Route**. Alternatively, press **Navigation Menu** ► **Cancel Route** on the All Menus screen.

The destination displayed at the bottom of the screen disappears and changes to .

 Press  to search for the target destination to obtain an optimum route.

 To maintain the specified destination and stop the route guidance, press and hold **Cancel Route** at the bottom of the screen. The guidance stops and the **Resume Route** button appears. You can use the button to search for a previous destination and resume route guidance.

Various ways to find routes

On the Navigation menu, you can set the destination by using various searches, such as entering the location information or selecting from recent destinations or categorized places.

Perform any of the following methods:

- On the All Menus screen, press **Navigation Menu**.
- On the control panel, press the **[NAV]** button.

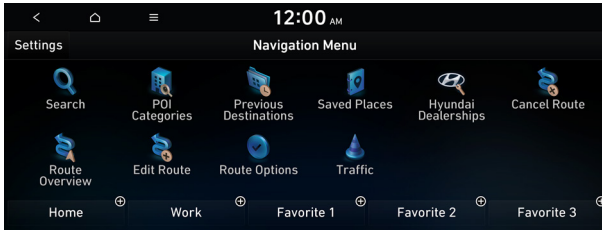



 Available icons and their arrangement may differ depending on the vehicle model and specifications.

Searching by keyword

Search for a location by entering various types of keywords such as place name, coordinates, and address.

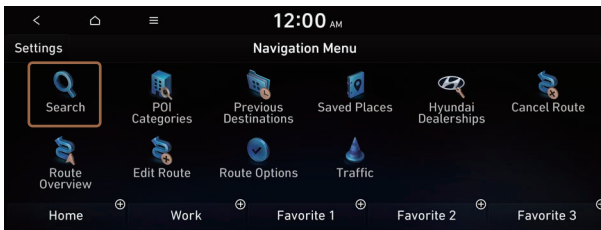
- 1 On the **Navigation Menu** screen, press **Search**.



 Available icons and their arrangement may differ depending on the vehicle model and specifications.

2 Enter the location data such as place name, address, or coordinates and then press **OK**.

- ✎ When there are any similar matches, the recommendations appear at the left of keypad.
- ✎ To access the online user's manual on the Search screen, press **☰ ▶ User's Manual on Web (QR Code)** and then scan the displayed QR code.

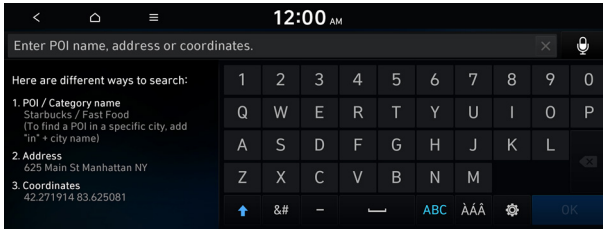

3 Select a destination from the search result.

- ✎ You can see the sites in the list on the preview screen at the right.
- ✎ To sort the search results in a different order, press on the attribute to toggle between options.

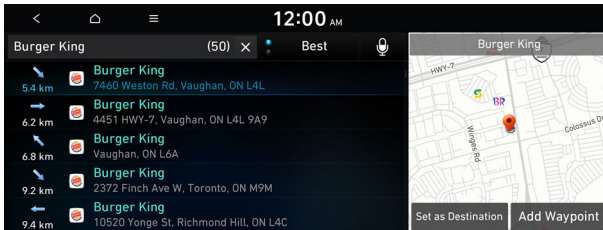

4 Check the location of the destination and then press **Set as Destination**.

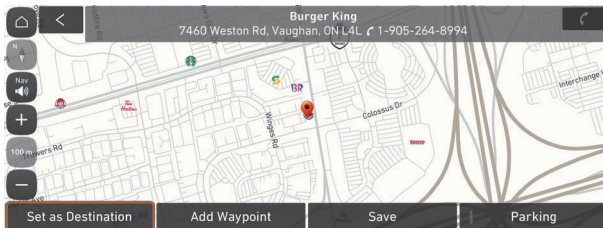

- ✎ If you press **Parking** at the bottom right of the screen, the map screen displays the location icon of the parking lot.

5 Select a route and press **Start Guidance**.

Searching from previous destinations

You can set a destination by selecting from the recently searched ones.

- 1 On the **Navigation Menu** screen, press **Previous Destinations**.

The navigated destinations appear in the list.

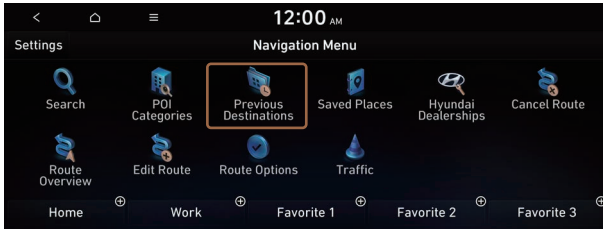

- ✎ Available icons and their arrangement may differ depending on the vehicle model and specifications.

- 2 Select the desired destination from the list.

- ✎ To sort the search results in a different order, press on the attribute to toggle between options.

- ✎ To access the online user's manual on the Previous Destinations screen, press  **User's Manual on Web (QR Code)** and then scan the displayed QR code.

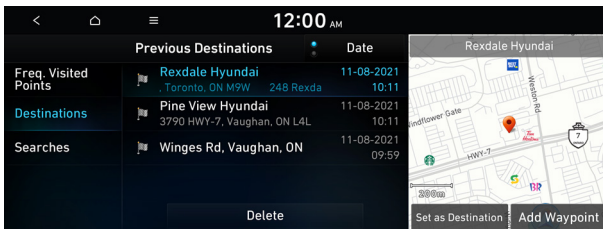

- 3 Check the location of the destination and then press **Set as Destination**.
- 4 Select a route and press **Start Guidance**.

Deleting a previous destination

- 1 On the Previous Destinations screen, press **Delete**.
- 2 Select the destination(s) to delete and press **Delete**.

You can delete the selected place(s) or all places.

Searching for Hyundai Dealerships

You can easily search for service centers or service stations.

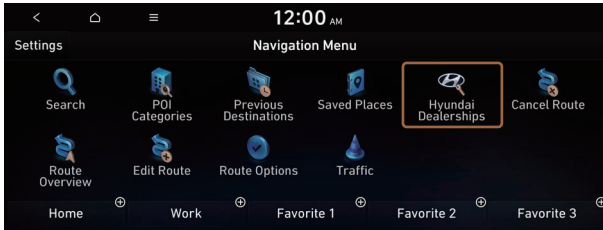

- 1 On the **Navigation Menu** screen, press **Hyundai Dealerships**.



 Available icons and their arrangement may differ depending on the vehicle model and specifications.

- 2 Select a Hyundai Dealerships from the list.

 To sort the search results in a different order, press on the attribute to toggle between options.

 To access the online user's manual, on the Hyundai Dealerships screen, press  **User's Manual on Web (QR Code)** and then scan the displayed QR code.

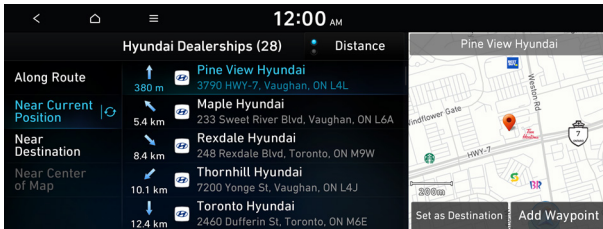

- 3 Check the location of the destination and then press **Set as Destination**.

- 4 Select a route and press **Start Guidance**.

Searching for nearby points of interest(POI)

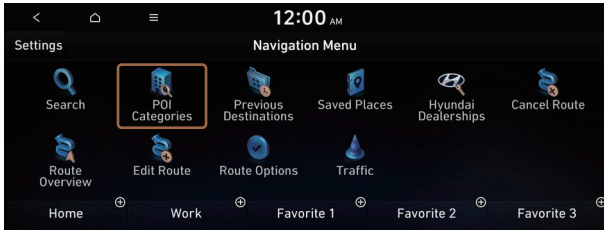

You can set a destination after searching the nearby points of interest by the category.

- 1 On the **Navigation Menu** screen, press **POI Categories**.



 Available icons and their arrangement may differ depending on the vehicle model and specifications.

- 2 Select a desired point according to the instructions.

 To access the online user's manual on the POI Categories screen, press  ► **User's Manual on Web (QR Code)** and then scan the displayed QR code.

 The screen may differ depending on the vehicle model and specifications.

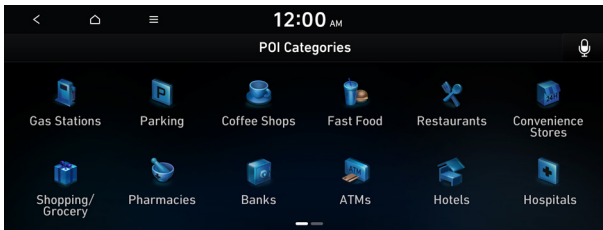

3 Select a destination from the search result.

- ✎ To display the result of search around a specific location, select a sort criteria from the list on the left of the screen.
- ✎ To sort the search results in a different order, press on the attribute to toggle between options.
- ✎ The screen may differ depending on the vehicle model and specifications.

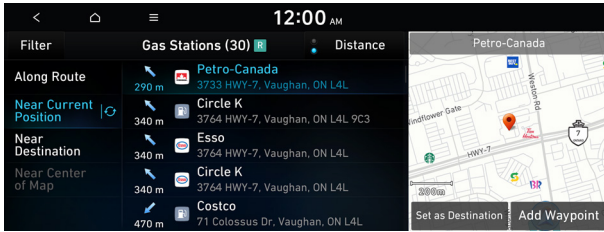

Option A

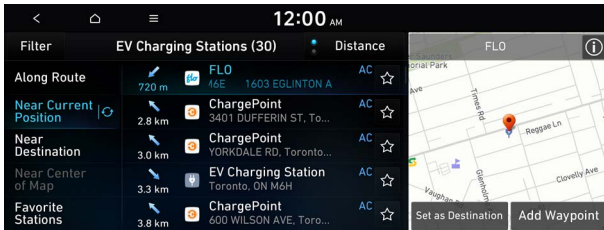

Option B (Type1, EV only)

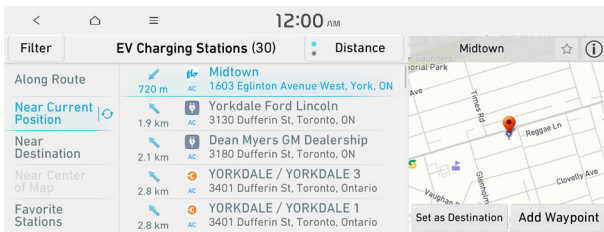

Option C (Type2, EV only)

- 4 Check the location of the destination and then press **Set as Destination**.
- 5 Select a route and press **Start Guidance**.

- ✎ To change the type of nearby POIs on the map, press **Menu** ► **Nearby Info**. ► **Nearby POIs**.
- ✎ To see nearby POIs during guidance on the map, press **Menu** ► **Nearby Info**. ► **POI Categories**.

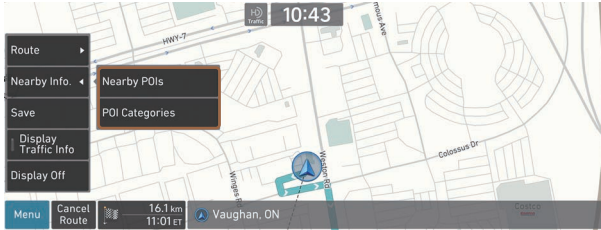

Editing the route

You can edit the waypoints on the way to the destination. You can add up to two waypoints.

Setting a waypoint

You can search for the desired place and set it as a waypoint.

- 1 On the **Navigation Menu** screen, press the desired search method to search for a waypoint.

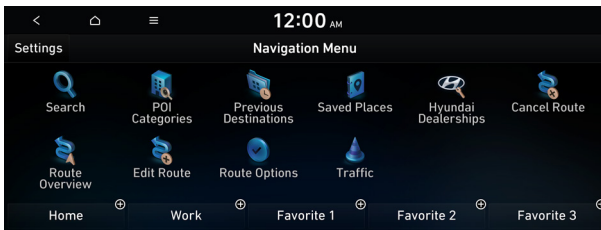

- ✎ Available icons and their arrangement may differ depending on the vehicle model and specifications.
- ✎ For more information about the waypoint search: ► see "Searching by keyword," "Searching from previous destinations," "Searching for nearby points of interest(POI)," "Searching for restaurants," "Searching for emergency services."

2 On the map for a search, press **Add Waypoint**.

The selected waypoint is added to the route.

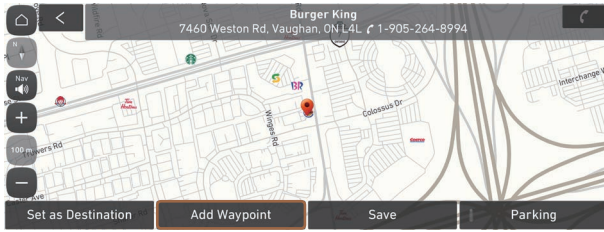

3 After adding waypoints, press **Calculate**.

🔗 To access the online user's manual on the Edit Route screen, press  **User's Manual on Web (QR Code)** and then scan the displayed QR code.

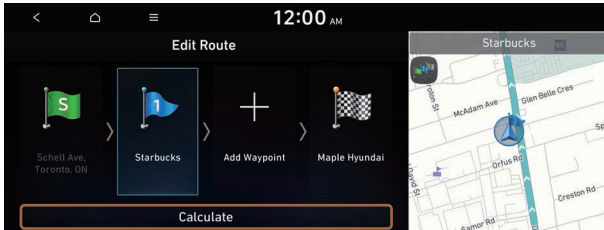

4 Select the updated route and then press **Start Guidance**.

Changing the order of waypoints

You can change the order of waypoints on the route.

1 On the **Navigation Menu** screen, press **Edit Route**.

2 Select a waypoint to change the order and then press **Change Order**.

🔗 To change the order of waypoints, press **Change Order**, then drag it to reposition.

🔗 To add another waypoint on the Edit Route screen, press **Add Waypoint**.

🔗 To see on the map, press  next to the name.

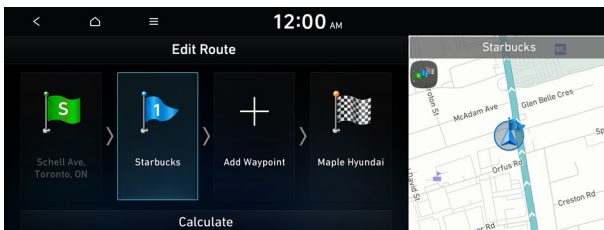

- 3 After editing the route, press **Calculate**.
- 4 Select the updated route and then press **Start Guidance**.

Deleting a waypoint

You can delete a waypoint from the route.

- 1 On the **Navigation Menu** screen, press **Edit Route**.
- 2 Select a waypoint to delete from the route and then press **Delete**.

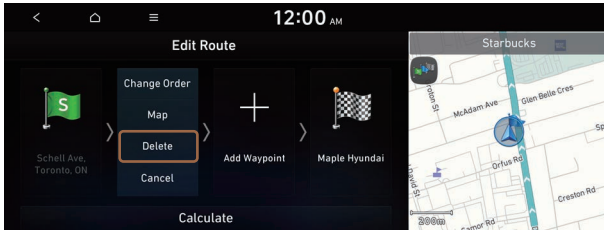

- 3 To search the route again after removing the waypoint, press **Calculate**.
- 4 Select the updated route and then press **Start Guidance**.

Changing the route search option

You can change the route search option.

- 1 On the **Navigation Menu** screen, press **Route Options**.
- 2 Select a route and press **Route Avoid Options**.

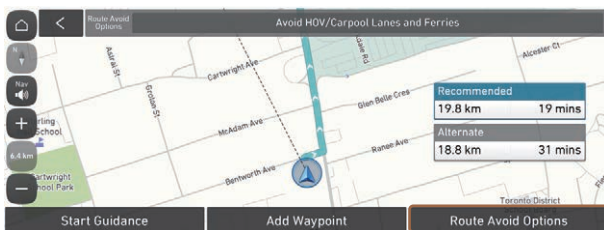

3 Select the search option and press **Recalculate**.

- ✎ To access the online user's manual on the Route Options screen, press  ► **User's Manual on Web (QR Code)** and then scan the displayed QR code.
- ✎ Available options may differ depending on the vehicle model and specifications.

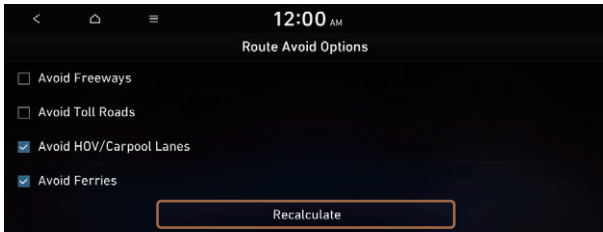

Avoiding specific zones

You can resume routing after excluding the specified roads such as congested roads or roads under construction.

- 1 On the **Navigation Menu** screen, press **Route Overview**.
- 2 Press **Route Info. / Avoid**.

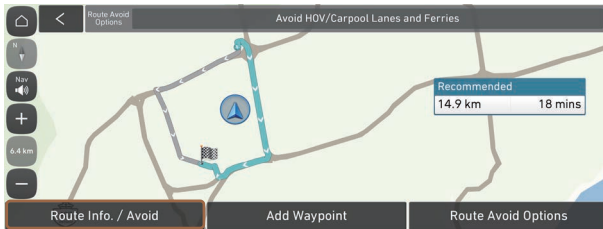

- ✎ The screen may differ depending on the vehicle model and specifications.

3 Select the roads to avoid and press **Recalculate**.

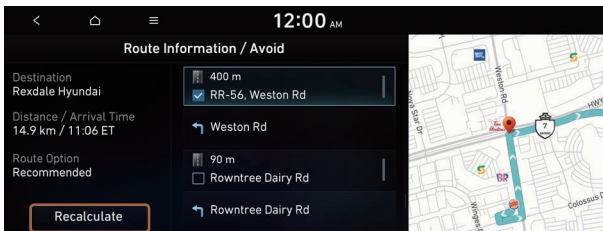

4 Press **Yes**.

5 Select the updated route and then press **Start Guidance**.

🔗 When there is any zone under construction ahead on the way, you are prompted to confirm whether or not to exclude the zone from the route. To avoid the zone, press **Yes** to resume routing.

Searching for restaurants

1 On the **Navigation Menu** screen, press **POI Categories** ► **Restaurants**.

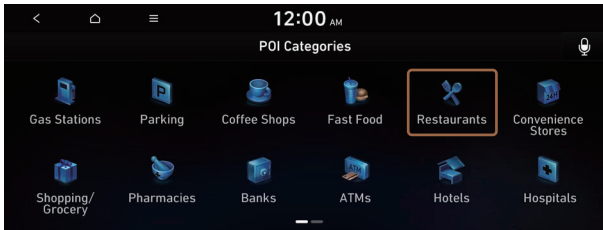

🔗 Available icons and their arrangement may differ depending on the vehicle model and specifications.

2 Select a destination from the search result.

🔗 To sort the search results in a different order, press on the attribute to toggle between options.

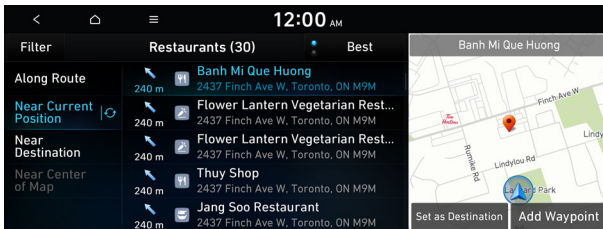



3 Check the location of the destination and then press **Set as Destination**.

4 Select a route and press **Start Guidance**.

Searching for emergency services

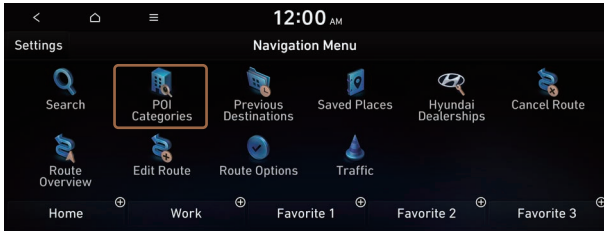
- 1 On the **Navigation Menu** screen, press **POI Categories**.



 Available icons and their arrangement may differ depending on the vehicle model and specifications.

- 2 Select the type of emergency service.

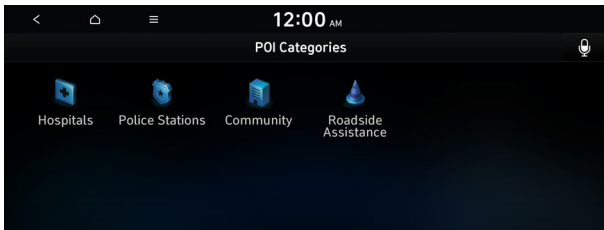

- 3 Select a destination from the search result.

 To sort the search results in a different order, press on the attribute to toggle between options.

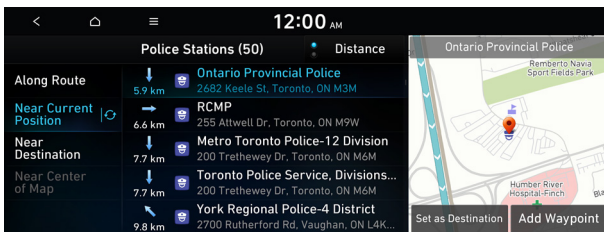

- 4 Check the location of the destination and then press **Set as Destination**.
- 5 Select a route and press **Start Guidance**.

Using saved favorite places

After registering the current location or frequently visited places, you can easily set any of them as a destination.

Saving a searched place as a favorite place

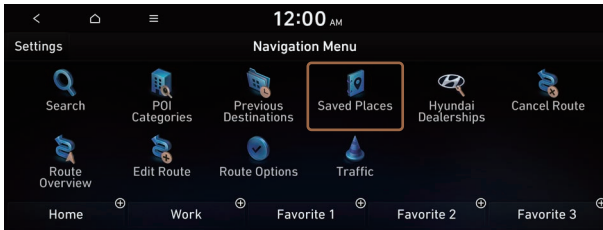

You can search and register the desired place.

- 1 On the **Navigation Menu** screen, press **Saved Places**.



 Available icons and their arrangement may differ depending on the vehicle model and specifications.

- 2 On the **Saved Places** screen, press **Saved Places**.

 To access the online user's manual on the Saved Places screen, press  ► **User's Manual on Web (QR Code)** and then scan the displayed QR code.

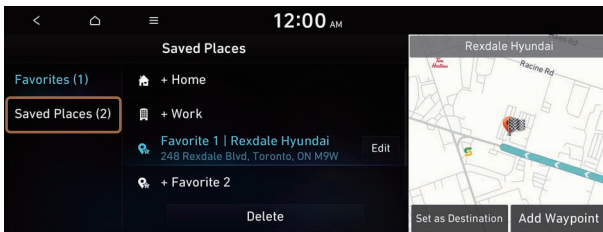

- 3 Press **Add**.

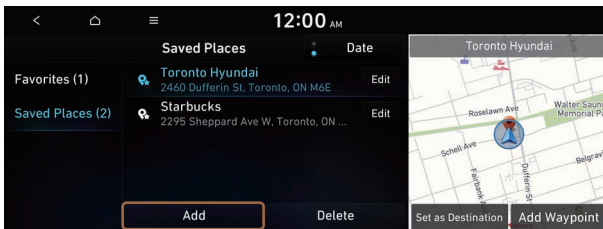

4 Press **Search** and enter a keyword for a search.

📍 You can also search for the place by using other methods. ▶ See "Various ways to find routes."

5 Check the location and information of the current position and then press **OK**.

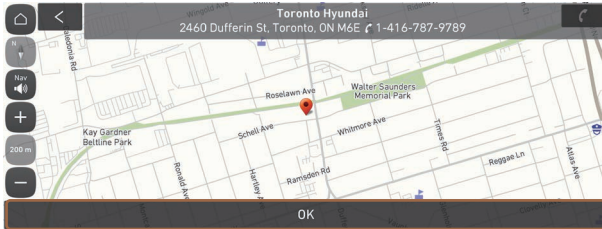

The place is registered as a favorite place.

Saving the current location as a favorite place

1 On the map screen, press **Menu** ▶ **Save**.

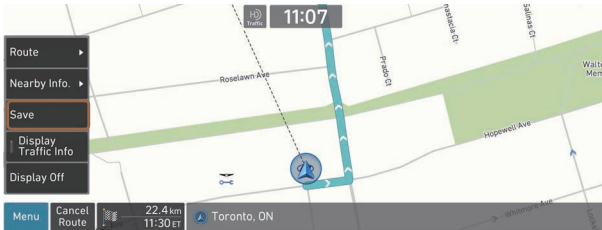

2 If necessary, press **Save** after making changes.

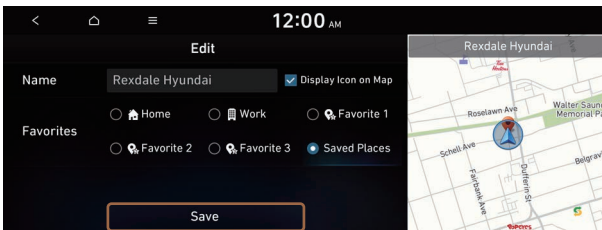



The place is registered as a favorite place.

Saving a frequently visited place as a favorite place

You can register your home, office, or other frequently visited place as a favorite.

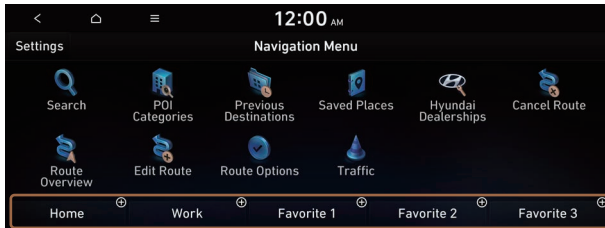
- 1 At the bottom of the **Navigation Menu** screen, select a button that has



 Available icons and their arrangement may differ depending on the vehicle model and specifications.

- 2 Press **Search** and enter a keyword for a search.
- 3 Check the location and information of the current position and then press **OK**.

The selected place is saved as a favorite and displayed as a shortcut button at the bottom of the Navigation Menu screen.

 When you press and hold a registered favorite, you can edit its location.

Setting a saved favorite place as the destination

You can set any in the saved place of the navigation system as a destination.

- 1 On the **Navigation Menu** screen, press **Saved Places**.
- 2 Select the desired option from the left of the screen.

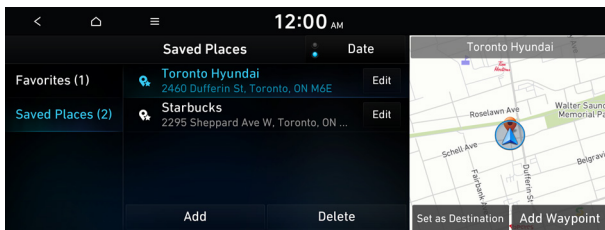

- 3 Select the place to set as a destination.
- 4 Check the location of the destination and then press **Set as Destination**.
- 5 Select a route and press **Start Guidance**.

Setting a frequently visited place as the destination

You can set your home, office, or other frequently visited places as a destination directly from your favorites list once you add them.

At the bottom of the **Navigation Menu** screen, press a desired shortcut button.

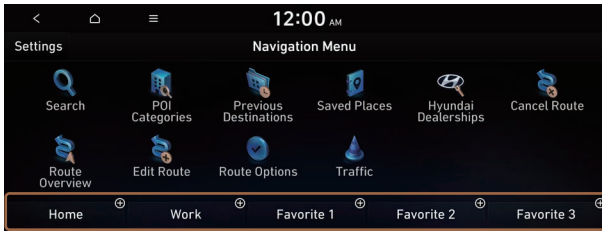

- ✍ When guidance to a destination is in progress, press **Change Destination**.
- ✍ Available icons and their arrangement may differ depending on the vehicle model and specifications.

Editing information about a saved favorite place

You can change information or properties of a registered location.

- 1 On the **Navigation Menu** screen, press **Saved Places**.
- 2 Select an option that contains the destination you want from the left of the screen.

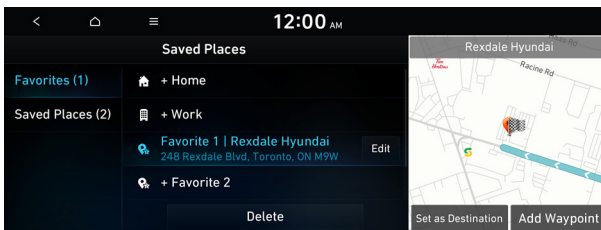

- 3 Press **Edit** next to the place for information change.
- 4 After changing the information, press **Save**.

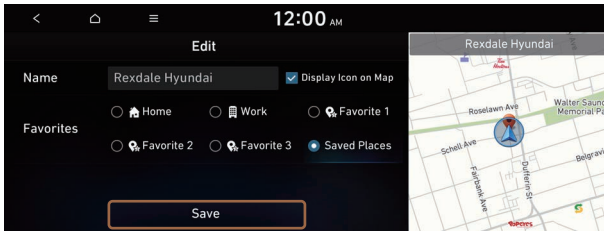

Deleting a saved favorite place

- 1 On the **Navigation Menu** screen, press **Saved Places**.
- 2 Select the desired group.
- 3 Among the registered favorite places, select a place to delete and press **Delete**.
- 4 Select the destination(s) to delete and press **Delete**.

Viewing traffic Information

You can see real-time traffic information such as ongoing road works or accidents.

- 1 On the **Navigation Menu** screen, press **Traffic**.

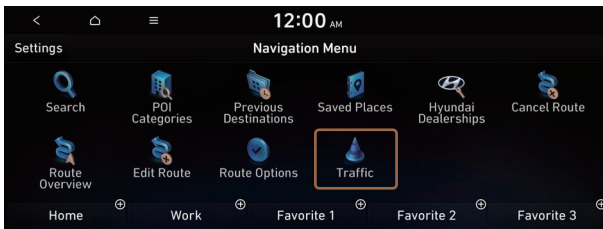

2 Select an item from the real-time traffic information list and see the details.

- ✎ To reroute using recent traffic information while in guidance, press **Detour**.
- ✎ To see traffic information along the current route or to see all available traffic information, press **On Route**.
- ✎ To select the type of traffic information, press **Filter**.

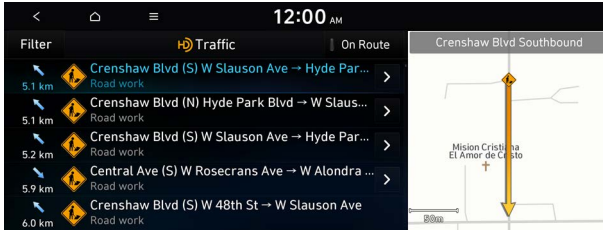

3 Check the detailed traffic information.



- ✎ Traffic information for border crossings and speed limits for individual roads may not be accurate. Depending on the road conditions, note the information.

Searching for gas stations

You can search nearby gas stations.

- 1 On the **Navigation Menu** screen, press **POI Categories** ► **Gas Stations**.

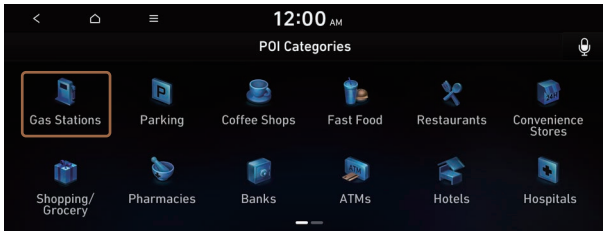

- ✎ Available icons and their arrangement may differ depending on the vehicle model and specifications.

- 2 Select a destination from the search result.

- ✎ To display the result of search around a specific location, select a sort criteria from the list on the left of the screen.
- ✎ To sort the search results in a different order, press on the attribute to toggle between options.

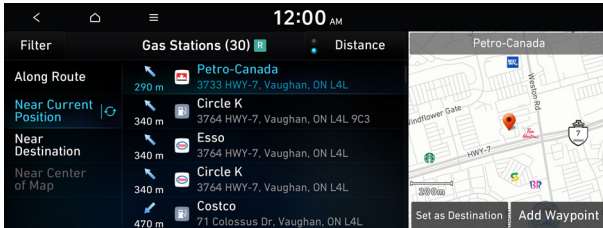

- 3 Check the location of the destination and then press **Set as Destination**.
- 4 Select a route and press **Start Guidance**.

Searching for EV (Electric Vehicle) charging stations (EV only)

You can search nearby charging stations.

- 1 On the **Navigation Menu** screen, press **POI Categories ► EV Charging Stations**.

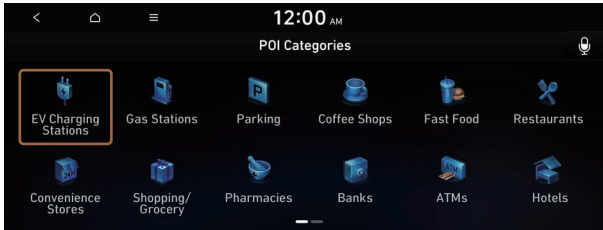

✎ Available icons and their arrangement may differ depending on the vehicle model and specifications.

- 2 Select a destination from the search result.

✎ To display the result of search around a specific location, select a sort criteria from the list on the left of the screen.

✎ To sort the search results in a different order, press on the attribute to toggle between options.

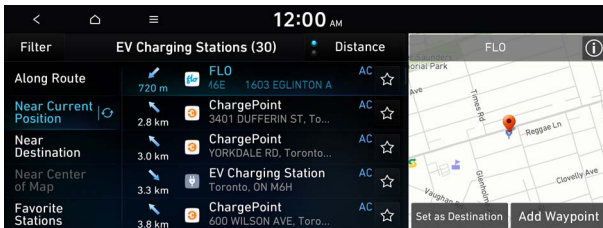

✎ The screen may differ depending on the vehicle model and specifications.

- 3 Check the location of the destination and then press **Set as Destination**.
- 4 Select a route and press **Start Guidance**.

END USER LICENSE AGREEMENT

PLEASE READ THIS END USER LICENSE AGREEMENT ("EULA") CAREFULLY BEFORE USING THE NAVIGATION SYSTEM.

This is a license agreement between you and Hyundai Autoever, CORP. including its affiliates ("COMPANY") regarding a copy of the COMPANY navigable map database together with associated software, media and explanatory printed documentation published by COMPANY (jointly the "Product"). The Product is provided for your personal, internal use only and not for resale. It is protected by copyright and is subject to the following terms which are agreed to by you, on the one hand, and COMPANY and its licensors (and their licensors and suppliers) (collectively, "Licensors") on the other hand.

By using the Product, you accept and agree to all terms and conditions in this End User License Agreement ("EULA"). IF YOU DO NOT AGREE TO THE TERMS OF THIS EULA, YOU MUST PROMPTLY EXIT THE PRODUCT OPERATION PROGRAM AND DO NOT USE OR ACCESS TO THE PRODUCT. YOU AGREE THAT YOUR RIGHTS UNDER THIS EULA MAY BE TERMINATED AUTOMATICALLY WITHOUT NOTICE IF YOU FAIL TO COMPLY WITH ANY TERM(S) OF THIS EULA.

Terms and Conditions

Personal Use Only. You agree to use this Product together with COMPANY's authorized application for the solely personal, non-commercial purposes for which you were licensed, and not for service bureau, time-sharing or other similar purposes. Accordingly, but subject to the restrictions set forth in the following paragraphs, you agree not to otherwise reproduce, copy, modify, decompile, disassemble, create any derivative works of, or reverse engineer any portion of this Data, and may not transfer or distribute it in any form, for any purpose, except to the extent permitted by mandatory laws. You may not assign this EULA or any of the rights or licenses granted under this EULA, except when installed in the system for which it was created.

Restrictions. Except where you have been specifically licensed to do so by COMPANY, and without limiting the preceding paragraph, you may not use the Product (i) with any products, systems, or applications installed or otherwise connected to or in communication with vehicles, capable of vehicle navigation, positioning, dispatch, real time route guidance, fleet management or similar applications; or (ii) with or in communication with any positioning devices or any mobile or wireless-connected electronic or computer devices, including without limitation cellular phones, palmtop and handheld computers, pagers, and personal digital assistants or PDAs.

COPYING OR USE OF THE PRODUCT EXCEPT AS PERMITTED BY THIS EULA IS UNAUTHORIZED AND IS COPYRIGHT INFRINGEMENT UNDER THE LAWS OF YOUR COUNTRY. IF YOU COPY OR USE THE PRODUCT WITHOUT COMPANY'S PERMISSION, EXCEPT AS PERMITTED BY THIS EULA, YOU ARE VIOLATING THE LAW AND LIABLE TO COMPANY AND ITS LICENSORS FOR DAMAGES, AND YOU MAY BE SUBJECT TO CRIMINAL PENALTIES.

THE PRODUCT MAY INCLUDE ENFORCEMENT TECHNOLOGY DESIGNED TO PREVENT (i) UNAUTHORIZED COPYING OF THE PRODUCT ONTO PHYSICAL STORAGE MEDIA OR VIA TRANSFER OVER THE INTERNET OR OTHER ELECTRONIC COMMUNICATION MEANS AND/OR (ii) ILLEGAL USAGE OF THE PRODUCT OTHER THAN BY A SPECIFICALLY AHTORIZED DEVICE. YOU AGREE THAT COMPANY MAY USE THESE MEASURES TO PROTECT COMPANY AND THE LICENSORS AGAINST COPYRIGHT INFRINGEMENT.

Uploads. The Product may provide functionality through which you are able to upload certain information about your use of the Product (collectively, "Uploads") to COMPANY's servers or receive other services from COMPANY (collectively, the "Services"). If you use such functionality, you authorize COMPANY to retain your Uploads on its servers. COMPANY will have no obligation to provide any Services, may change the form and nature of any Services at any time with or without notice to you, will have no liability whatsoever to you for any failure of the Product or Services to transmit your Uploads to or from COMPANY's servers, may cease providing any Services at any time with or without notice to you, and will have no obligation to retain your Uploads (or any other materials you may provide to COMPANY) on its servers or return your Uploads (or any other materials you may provide to COMPANY) to you before deleting them from its servers.

Storage. The Product may provide functionality through which you are able to store information (such as images) on the device on which you are using the Product. COMPANY will have no liability whatsoever to you or any third party for any failure of the Product to store any such information on such device.

Personal Information. By using the Product, you agree to the collection, retention and processing of your personal data (including the location of your mobile device) by COMPANY and to the storage and processing of such personal information on computers located outside of the country in which you reside. Even though COMPANY has taken steps intended to protect your personal information from being intercepted, accessed, used, or disclosed by unauthorized persons, COMPANY cannot fully eliminate security risks associated with your personal information and cannot guarantee that its systems will not be breached. See [*] for additional information regarding COMPANY's use of your personal information.

WARNING. THE PRODUCT REFLECTS REALITY AS EXISTING BEFORE YOU RECEIVED THE PRODUCT AND IT COMPRISES DATA AND INFORMATION FROM GOVERNMENT OTHER SOURCES. ACCORDINGLY, THE PRODUCT MAY CONTAIN INACCURATE OR INCOMPLETE INFORMATION DUE TO THE PASSAGE OF TIME, CHANGING CIRCUMSTANCES, SOURCES USED AND THE NATURE OF COLLECTING COMPREHENSIVE GEOGRAPHIC PRODUCT, ANY OF WHICH MAY LEAD TO INCORRECT RESULTS. THE PRODUCT AND SERVICES MAY NOT TO BE USED FOR SAFETY OF LIFE APPLICATIONS, OR FOR ANY OTHER APPLICATION IN WHICH THE ACCURACY OR RELIABILITY OF THE PRODUCT OR SERVICES COULD CREATE A SITUATION WHERE PERSONAL INJURY OR DEATH MAY OCCUR. **DO NOT ATTEMPT TO CONFIGURE THE PRODUCT OR INPUT INFORMATION WHILE DRIVING. FAILURE TO PAY FULL ATTENTION TO THE OPERATION OF YOUR VEHICLE COULD RESULT IN DEATH, SERIOUS INJURY, OR PROPERTY DAMAGE. BY USING THE PRODUCT, YOU ASSUME ALL RESPONSIBILITY AND RISK.**

Disclaimer of Warranty. The Product is provided to you "as is," and you agree to use it at your own risk. SUBJECT TO THE APPLICABLE LAWS, COMPANY AND THE LICENSORS MAKE NO GUARANTEES, REPRESENTATIONS OR WARRANTIES OF ANY KIND, EXPRESS OR IMPLIED, ARISING BY LAW OR OTHERWISE, INCLUDING BUT NOT LIMITED TO, CONTENT, QUALITY, ACCURACY, COMPLETENESS, EFFECTIVENESS, RELIABILITY, PERFORMANCE, MERCHANTABILITY, FITNESS FOR A PARTICULAR PURPOSE, NON-INFRINGEMENT, USEFULNESS, USE OR RESULTS TO BE OBTAINED FROM THE PRODUCT, OR THAT THE PRODUCT OR SERVER WILL BE UNINTERRUPTED OR ERROR-FREE, OR THAT ERRORS IN THE PRODUCT OR NONCONFORMITY TO ITS DOCUMENTATION CAN OR WILL BE CORRECTED. YOU ACKNOWLEDGE THAT THE PROVISIONS OF THIS SECTION ARE A MATERIAL INDUCEMENT AND CONSIDERATION TO COMPANY AND THE LICENSORS TO GRANT THE LICENSE CONTAINED IN THIS EULA AND TO PROVIDE YOU WITH ACCESS TO THE SERVICES.

Limitation of Liability: TO THE MAXIMUM EXTENT PERMITTED UNDER THE APPLICABLE LAWS, COMPANY AND THE LICENSORS SHALL NOT BE LIABLE TO YOU: IN RESPECT OF ANY CLAIM, DEMAND OR ACTION, IRRESPECTIVE OF THE NATURE OF THE CAUSE OF THE CLAIM, DEMAND OR ACTION ALLEGING ANY LOSS, INJURY OR DAMAGES, DIRECT OR INDIRECT, INCURRED BY YOU OR ANY THIRD PARTY WHICH MAY ARISE IN CONNECTION WITH OR RESULT FROM THE USE OR POSSESSION OF THE PRODUCT; OR FOR ANY LOSS OF DATA, PROFIT, REVENUE, CONTRACTS OR SAVINGS, OR OTHER DIRECT, INDIRECT, INCIDENTAL, SPECIAL OR CONSEQUENTIAL DAMAGES ARISING OUT OF YOUR USE OF OR INABILITY TO USE THE PRODUCT, ANY DEFECT IN THE PRODUCT, OR THE BREACH OF THESE TERMS OR CONDITIONS, WHETHER IN AN ACTION IN CONTRACT OR TORT OR BASED ON A WARRANTY, EVEN IF COMPANY OR THE LICENSORS HAVE BEEN ADVISED OF THE POSSIBILITY OF SUCH DAMAGES AND NOTWITHSTANDING THE FAILURE OF ANY LIMITED REMEDY PROVIDED HEREIN.

Exclusions. Some jurisdictions do not allow certain warranty exclusions or the limitation or exclusion of liability, so to that extent the above exclusion may not apply to you. To the extent that COMPANY may not, as a matter of applicable law, disclaim any implied warranty or limit its liabilities, the scope and duration of such warranty and the extent of COMPANY's liability shall be the minimum permitted under such applicable law. The disclaimer of warranty and limitation of liability set forth in this EULA does not affect or prejudice your statutory rights where you have acquired the Product otherwise than in the course of business.

Third-Party Copyright Notices. The third-party sourced data has been incorporated into or made a part of the Product and is being sublicensed to you subject to the terms and conditions of this EULA. In this regard, you shall not remove or tamper with any intellectual property rights notice attached or used in relation to data supplied by the Licensors.

Entire Agreement. This EULA is the entire agreement between COMPANY (and the Licensors) and you pertaining to the subject matter hereof, and supersedes in their entirety any and all previous written or oral communications or documents (including, if you are obtaining an update, any agreement that may have been included with an earlier version of the Product) with respect to such subject matter.

Governing Law. This EULA shall be governed by the laws of the jurisdiction in which you reside at the date of acquisition of the Product. Should you at that moment reside outside the European Union or Switzerland, the law of the jurisdiction within the European Union or Switzerland where you acquired the Product shall apply. In all other cases, or if the jurisdiction where you acquired the Product cannot be defined, the laws of the Republic of Korea shall apply. This EULA will not be governed by the U.N. Convention on Contracts for the International Sale of Goods. The courts competent at your place of residence at the time you acquired the Product shall have jurisdiction over any dispute arising out of, or relating to this EULA, without prejudice to COMPANY's right to bring claims at your then current place of residence.

Export Control. You agree not to export or re-export from anywhere any part of the Product in any form except in compliance with applicable export laws, rules and regulations, including but not limited to the laws, rules and regulations administered by the Office of Foreign Assets Control of the U.S. Department of Commerce and the Bureau of Industry and Security of the U.S. Department of Commerce.

Miscellaneous. If any provision of this EULA is found to be invalid or unenforceable, it will be enforced to the extent permissible and the remainder of this EULA will remain in full force and effect. Failure by COMPANY to prosecute any right with respect to a default hereunder will not constitute a waiver by COMPANY of the right to enforce rights with respect to the same or any other breach. No refunds or replacements will be permitted on damaged Product.

U.S. Government End Users. If the Product is being acquired by or on behalf of the United States Government or any other entity seeking or applying rights similar to those customarily claimed by the United States Government, this Product and related documentation are "Commercial Items" as that term is defined at 48 C.F.R. ("FAR") 2.101. This Product and related documentation are licensed to the United States Government end users (a) only as "Commercial Items" and (b) with only those rights as are granted to all other end users in accordance with this EULA, and each copy of Product delivered or otherwise furnished shall be marked and embedded as appropriate with the following "Notice of Use," and shall be treated in accordance with such Notice:

NOTICE OF USE

CONTRACTOR (MANUFACTURER/ SUPPLIER) NAME: Hyundai Autoever, CORP

CONTRACTOR (MANUFACTURER/SUPPLIER) ADDRESS: 510, Teheran-ro, Gangnam-gu, Seoul,
Republic of Korea

This Product and related documentation are commercial items as defined in FAR 2.101 and is subject to this EULA under which this Product is provided.

© 2021 Hyundai Autoever. All rights reserved

If the Contracting Officer, federal government agency, or any federal official refuses to use the legend provided herein, the Contracting Officer, federal government agency, or any federal official must notify COMPANY prior to seeking additional or alternative rights in the Product.

End-User Terms Required by HERE. The Product utilizes map data that COMPANY licenses from HERE and the following copyright notices apply to such map data (the "HERE Data"): © 2021 HERE. All rights reserved.

The HERE Data for areas of Canada includes information taken with permission from Canadian authorities, including: © Her Majesty the Queen in Right of Canada, © Queen's Printer for Ontario, © Canada Post Corporation, GeoBase®, © Department of Natural Resources Canada. All rights reserved.

HERE holds a non-exclusive license from the United States Postal Service® to publish and sell ZIP+4® information.

©United States Postal Service® 2021. Prices are not established, controlled or approved by the United States Postal Service®.

The following trademarks and registrations are owned by the USPS: United States Postal Service, USPS, and ZIP+4.

The HERE Data for Mexico includes certain data from Instituto Nacional de Estadística y Geografía.

Austria: © Bundesamt für Eich- und Vermessungswesen

Croatia, Cyprus, Estonia, Latvia, Lithuania, Moldova, Poland, Slovenia and/or Ukraine: © EuroGeographics

France: source: © IGN 2021 – BD TOPO ®

Germany: Die Grundlagendaten wurden mit Genehmigung der zuständigen Behörden entnommen

Great Britain: Contains Ordnance Survey data © Crown copyright and database right 2021, and Royal Mail data © Royal Mail copyright and database right 2021.

Greece: Copyright Geomatics Ltd.

Italy: La Banca Dati Italiana è stata prodotta usando quale riferimento anche cartografia numerica ed al tratto prodotta e fornita dalla Regione Toscana.

Norway: Copyright © 2021; Norwegian Mapping Authority

Portugal: Source: IgeoE – Portugal

Spain: Información geográfica propiedad del CNIG

Sweden: Based upon electronic data Ó National Land Survey Sweden

Switzerland: Topografische Grundlage: Ó Bundesamt für Landestopographie

United Kingdom: Contains public sector information licensed under the Open Government Licence v1.0 (see for the license <http://www.nationalarchives.gov.uk/doc/open-government-licence/>) and is adapted from data from the office for National Statistics licensed under the Open Government Licence v.1.0.

Israel: © Survey of Israel data source

Jordan: © Royal Jordanian Geographic Centre. The foregoing notice requirement for Jordan Data is a material term of the Agreement. If Client or any of its permitted sublicensees (if any) fail to meet such requirement, HERE shall have the right to terminate Client's license with respect to the Jordan Data.

Mozambique: Certain Data for Mozambique provided by Cenacarta © 2021 by Cenacarta

Réunion: source: © IGN 2021 - BD TOPO ®

End-User Terms Required by ZENRIN. The Product utilizes map data that COMPANY licenses from ZENRIN and the following copyright notices apply to such map data (the "ZENRIN Data"):

Europe: Junction View Data provided by ZENRIN CO., LTD. Copyright © 2021, All Rights Reserved.

Europe: Junction View Data and Exit View Data provided by ZENRIN CO., LTD. Copyright © 2021, All Rights Reserved.

North America: Junction View Data provided by ZENRIN USA, INC. Copyright © 2021, All Rights Reserved; Junction View Data fourni par ZENRIN USA, INC. Copyright © 2021. Tous droits réservés; Las imágenes de las rutas alternas son proveídas por ZENRIN USA, INC. Copyright © 2021. Todos los derechos reservados.

© 2021 Hyundai Autoever. All rights reserved.

Copyright for Brand Icon

The marks of companies displayed by this product to indicate business locations are the marks of their respective owners. The use of such marks in this product does not imply any sponsorship, approval, or endorsement by such companies of this product.

Copyright for Junction View

Junction View Data provided by ZENRIN USA, INC. Copyright© 2021, All rights Reserved.

About Map Updates

To find the latest map update:

- Visit <https://update.hyundai.com/CA/EN/Main>.
- Call Hyundai Customer Care (1-888-216-2626).
- Or visit your local Hyundai dealer.



The Data and all copyrights and intellectual property or neighboring rights therein are owned by HERE and Hyundai Autoever, CORP.

Importance Notice: This is protected by U.S. copyright laws.

You may not extract or reutilize substantial parts of the contents of the Data, nor reproduce, copy, modify, adapt, translate, disassemble, decompile or reverse engineer any portion of the Data, except to the extent explicitly permitted by mandatory laws.

© 1987-2021 HERE. All rights reserved.

06

Phone

Connecting a Bluetooth device

Making a call via Bluetooth

Accepting an incoming call over Bluetooth

Checking new messages over Bluetooth

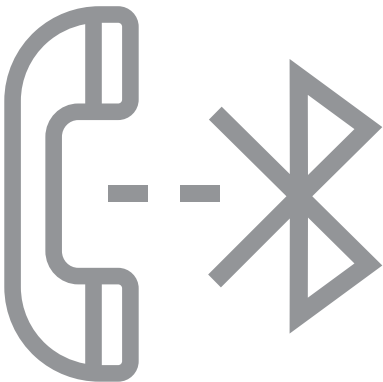

Connecting a Bluetooth device

Bluetooth is a short-range wireless networking technology. The Bluetooth communication function allows you to exchange data by connecting a Bluetooth device to another neighboring Bluetooth device without a cable connection. With this function, you can use different types of devices more efficiently.

To make a phone call or play audio from a Bluetooth device, check the following first:

- For a device that is not registered to the system, ► see "Registering a device."
- A registered device will automatically connect to the system when you bring it near the system. If it does not automatically connect, ► see "Connecting a registered device," "Disconnecting a registered device."



Warning

- Driving while distracted can result in a loss of vehicle control that may lead to an accident, severe bodily injury, or death. The driver's primary responsibility is the safe and legal operation of the vehicle, and the use of any vehicle systems, including the touch screen and steering wheel controls, which take the driver's eyes, attention, and focus away from the safe operation of the vehicle, or which are not permissible by law, should never be used during the operation of the vehicle.
- Park the vehicle at a safe place before connecting a Bluetooth device to the system. It may take the driver attention off the road and cause a traffic accident which can result in damages, injuries, and/or death.



The Bluetooth connection function supports only the hands-free and audio related functions. Connect your mobile phone, MP3 player, or device that supports the hands-free or audio function.

Registering a device

To connect a Bluetooth device to the system, first add the device to the list of Bluetooth devices on the system.



The screen may differ depending on the vehicle model and specifications.

1 On the All Menus screen, press **Setup ► Device Connections ► Device Connections ► Add New.**



To register a device for the first time, press the Call button on the steering wheel or by pressing **Phone** on the All Menus screen.

2 Turn on Bluetooth on the Bluetooth device to connect and select the vehicle system on the list of searched devices.

 The system's Bluetooth name can be seen on the Add New Device window.

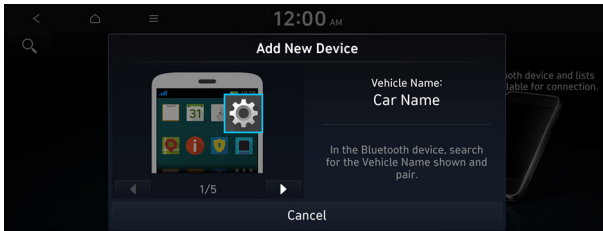



3 Check that the authentication code on the Bluetooth device screen matches the one on the system screen and approve the connection on the device.

4 When your smartphone is using Bluetooth communication, to download contacts from the phone to the system or use the text message notification, allow access to your phone.

 Access is only required to use Bluetooth calling. There will be no access request when you connect an audio device.

 After the access request is approved, it may take a while until the Bluetooth connection is completed. As soon as the Bluetooth connection is completed, the Bluetooth connection indicator icon appears at the top of the screen.

 Access to data can be enabled or disabled by using the Bluetooth Settings menu on the mobile phone. For more details, refer to the mobile phone's user manual.

 In order not to use the automatic Bluetooth connection, turn off the Bluetooth function on the device. To use this function again, turn on the Bluetooth function on the device.

 You can add Bluetooth devices up to 6.

Connecting a registered device

To use a Bluetooth device, first connect a registered Bluetooth device to the system.

✍ You can add one Bluetooth hands-free kit or up to two Bluetooth audio devices.

- 1 On the All Menus screen, press **Setup ► Device Connections ► Device Connections**.
- 2 Press the icons to connect.

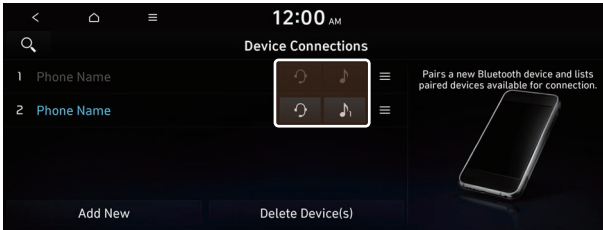

✍ If you cannot connect your device, check to make sure its Bluetooth option is enabled.

✍ When the connection is terminated abnormally due to being out of range or device failures, the connection is automatically restored as soon as the device returns to the connection range or normal state.

Bluetooth connection screen

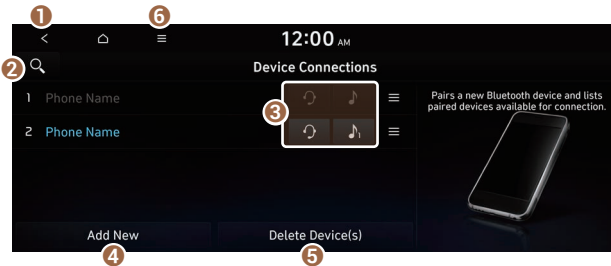

- 1 Returns to the previous step.
- 2 Search for a setting item by voice or by entering a keyword.
- 3 Select hands-free or Bluetooth audio to connect or disconnect Bluetooth devices.
- 4 Add a new device to the system.
- 5 Delete a registered device from the system.
- 6 The list of menu items appears.
 - **Display Off:** Turns off the screen. To switch the screen back on, press the screen or briefly press the power button.
 - **Auto Connection Priority:** Set the priority order for automatic Bluetooth connection to the system when it turns on (if equipped).
 - **Search for Settings:** Search for a setting item by voice or by entering a keyword.
 - **Phone Projection Settings:** Change the settings related to phone projection (if equipped).
 - **User's Manual on Web (QR Code):** Displays the QR code that provides access to the online user manual for the system.

Disconnecting a registered device

- 1 On the All Menus screen, press **Setup ► Device Connections ► Device Connections**.
- 2 Press the connected icons.

Deleting a registered device

If you will no longer use a Bluetooth device or you want to add a new device when 6 devices are already registered, delete an existing registered device.

- 1 On the All Menus screen, press **Setup ► Device Connections ► Device Connections ► Delete Device(s)**.
 - 2 Select a device to delete and press **Delete**.
To delete all registered devices, press **Mark All ► Delete**.
 - 3 Press **Yes**.
- 🔗 When you delete a registered device, all related contacts, call logs, and text messages are removed from the system.

Making a call via Bluetooth

You can connect a Bluetooth device with the hands-free function to use a Bluetooth phone. The Bluetooth connection allows you to view call details directly from the system screen, and to make calls safely and easily use your vehicle microphone and speaker.

Warning

- Park the vehicle at a safe place before connecting your mobile phone. It may take the driver attention off the road and cause a traffic accident which can result in damages, injuries, and/or death.
- While driving, do not make a call by dialing a phone number or do not pick up your phone to talk. Distraction by the use of a mobile phone may cause you not to recognize traffic flow around and not to cope with unexpected situations. As a result, a traffic accident may occur. If necessary, use the Bluetooth hands-free function and make the call as short as possible.

Dialing from the recent call list

Make calls directly from call history of your mobile device.

When you connect your mobile device and system over Bluetooth, the list of recent calls from the device will be downloaded to the system and you can call them again by selecting them from the system screen. Your vehicle has a built-in microphone and speaker that make using mobile phones safe and easy.

1 Perform any of the following methods:

- On the All Menus screen, press **Phone**.
- On the steering wheel, press the Call button.

2 On the Bluetooth Call screen, press .

3 Choose a name from the list.

The system dials the selected number.

 You can also move to a desired number by using the Move lever/button on the steering wheel without pressing on the screen.

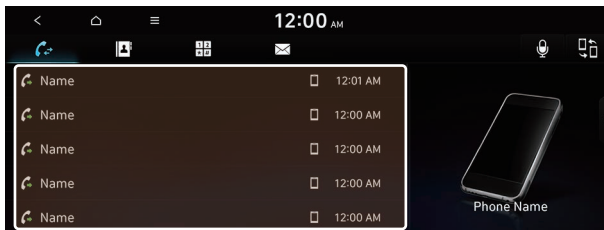

- ✍ The download may not work in some phone models.
- ✍ You can download up to 50 call records for each list.
- ✍ Call durations do not appear on the system screen.
- ✍ You cannot download call records when the download is prohibited by the phone. Some phone models may require approval for a download. When a successful download is not made, check the phone screen or its settings.
- ✍ When call records are newly downloaded, the previous records are removed.
- ✍ Learn more about receiving calls while using a Bluetooth connection. ► See "Accepting an incoming call over Bluetooth."

Recent calls list screen

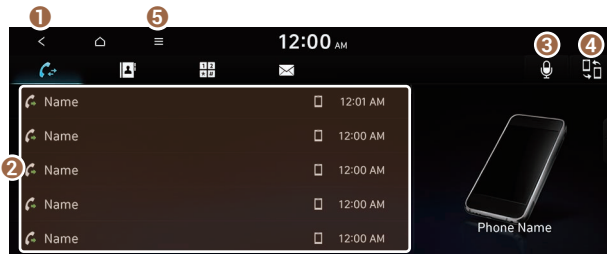

- 1 Returns to the previous step.
 - 2 View a list of recent calls downloaded to the system from the device.
 - 3 Make a phone call using voice recognition. ► See "Dialing with voice recognition."
 - 4 Find and connect other Bluetooth devices.
 - 5 The list of menu items appears.
 - **Display Off:** Turns off the screen. To switch the screen back on, press the screen or briefly press the power button.
 - **Download:** Download the list of recent calls from the connected mobile device.
 - **Privacy Mode:** Activate privacy mode to protect personal data. The data downloaded from the mobile phone stays hidden while this mode is on.
 - **Change Device:** Find and connect other Bluetooth devices.
 - **Device Connections Settings:** Can change the Bluetooth settings.
 - **User's Manual on Web (QR Code):** Displays the QR code that provides access to the online user manual for the system.
 - **Split Screen:** Can turn on or off the split screen mode.
- ✍ The screen may differ depending on the vehicle model and specifications.

Dialing from the favorite contacts list (if equipped)

Make a list of frequently used phone numbers to call them quickly in the future.



When you connect your mobile device and system over Bluetooth, your contacts stored on the device will be downloaded to the system, and you can add frequently used phone numbers to the favorites list. Call your favorite contacts quickly and easily by selecting them from the list.



1 Perform any of the following methods:

- On the All Menus screen, press **Phone**.
- On the steering wheel, press the Call button.

2 On the Bluetooth Call screen, press .

3 On the favorites screen, press **Add New** and select a name from the displayed list.

 If you already have contacts on your favorites list, press  ► **Edit** on the Favorites screen.

 To search for a contact by entering a name or phone number on your contacts list, press  ► **Search**.

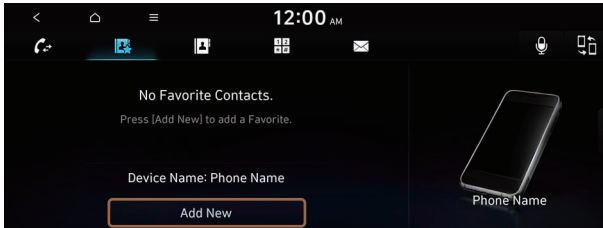

- 4 To set a phone number as a favorite, press the  button next to it. The phone number is now added to your favorites list.

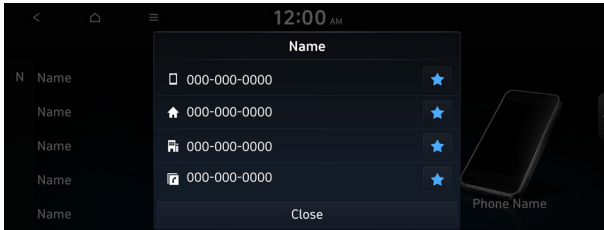

- 5 Choose a contact from the list. The system dials the selected contact.

- ✍ You can add up to 10 favorite contacts for each device.
- ✍ When another mobile phone is connected, the screen does not display the contacts from the previous phone, but they are kept in the system until the phone is deleted from the list.
- ✍ Learn more about receiving calls while using a Bluetooth connection. ► See "Accepting an incoming call over Bluetooth."

Favorites screen

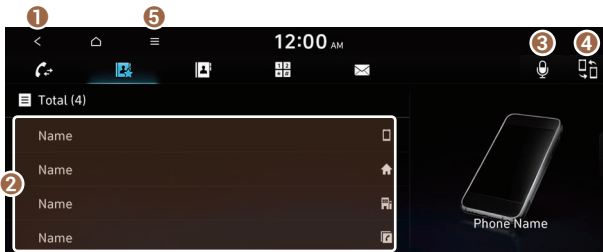

- 1 Returns to the previous step.
- 2 View a list of favorite contacts.
- 3 Make a phone call using voice recognition. ► See "Dialing with voice recognition."
- 4 Find and connect other Bluetooth devices.

- 5 The list of menu items appears.
- **Display Off:** Turns off the screen. To switch the screen back on, press the screen or briefly press the power button.
 - **Add New/Edit:** Add a new contact or edit the favorites list from downloaded contacts.
 - **Delete:** Delete a contact from the favorites list.
 - **Privacy Mode:** Activate privacy mode to protect personal data. The data downloaded from the mobile phone stays hidden while this mode is on.
 - **Change Device:** Find and connect other Bluetooth devices.
 - **Device Connections Settings:** Can change the Bluetooth settings.
 - **User's Manual on Web (QR Code):** Displays the QR code that provides access to the online user manual for the system.
 - **Split Screen:** Can turn on or off the split screen mode.

Dialing from the contacts

You can use contacts from the connected mobile device on the system.

When you connect your mobile device with the system via Bluetooth, contacts from the device are downloaded to the system, and you can choose to call them from the system screen. The system has a built-in microphone and speaker that make using mobile phones safe and easy.

1 Perform any of the following methods:

- On the All Menus screen, press **Phone**.
- On the steering wheel, press the Call button.

2 On the Bluetooth Call screen, press .

3 Select a contact from the list.

The system dials the selected contact.

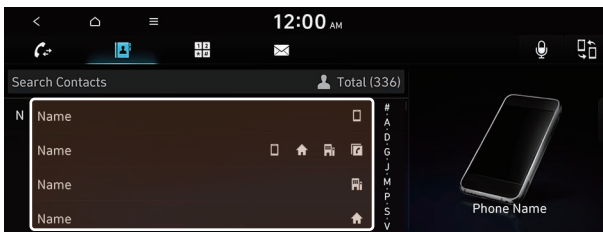

- ✎ You can download only the contacts that can be displayed on the connected Bluetooth device. The contacts may not appear in some Apps.
- ✎ You can download up to 5,000 contacts for each device.
- ✎ The download may not work in some phone models.
- ✎ Contacts from both the mobile device and its SIM card are downloaded at the same time. The system may not be able to download SIM card contacts from all phone models.
- ✎ When speed dial numbers are set to contacts on the phone, press and hold a speed dial number on the dial pad to make a call easily. Some mobile phone models may not support the speed dial function.
- ✎ You cannot download contacts when the download is prohibited by the phone. Some phone models may require approval for a download. When a successful download is not made, check the phone screen or its settings.
- ✎ Depending on the phone model or operation status, downloading may take longer than usual.
- ✎ When a new contacts list is downloaded, the previous records are removed.
- ✎ The downloaded contacts cannot be edited or deleted from the system.
- ✎ When another mobile phone is connected, the screen does not display the contacts downloaded from the previous phone, but they are kept in the system until the phone is deleted from the list.
- ✎ Learn more about receiving calls while using a Bluetooth connection. ► See "Accepting an incoming call over Bluetooth."

Contacts list screen

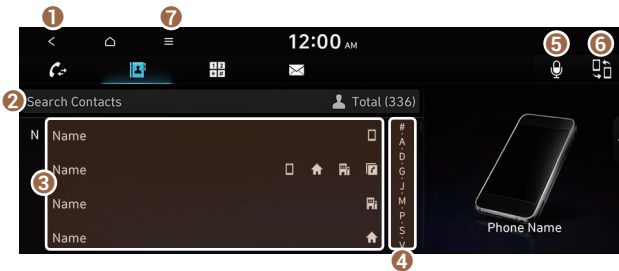

- 1 Returns to the previous step.
- 2 Enter a contact's name or phone number to search the list. You can also search for a contact by pressing  and saying the contact's name or phone number.
- 3 View a list of contacts downloaded to the system from the device.

- 4 Use the index to quickly find the contact you are looking for.
- 5 Make a phone call using voice recognition. ► See "Dialing with voice recognition."
- 6 Find and connect other Bluetooth devices.
- 7 The list of menu items appears.
 - **Display Off:** Turns off the screen. To switch the screen back on, press the screen or briefly press the power button.
 - **Download:** Download the list of contacts from the connected mobile device.
 - **Search:** Search contacts by entering a name or a phone number.
 - **Privacy Mode:** Activate privacy mode to protect personal data. The data downloaded from the mobile phone stays hidden while this mode is on.
 - **Change Device:** Find and connect other Bluetooth devices.
 - **Device Connections Settings:** Can change the Bluetooth settings.
 - **User's Manual on Web (QR Code):** Displays the QR code that provides access to the online user manual for the system.
 - **Split Screen:** Can turn on or off the split screen mode.

Dialing using the dial pad

Enter a phone number using the dial pad to make a call.

When you connect your mobile device to the system via Bluetooth, you can enter and dial a phone number from the system screen, without interacting with the device. Your vehicle has a built-in microphone and speaker that make using mobile phones safe and easy.

Warning

Do not manually dial a call while driving. Distraction by the use of a mobile phone may cause you not to recognize traffic flow around and not to cope with unexpected situations. As a result, a traffic accident may occur.

- 1 Perform any of the following methods:
 - On the All Menus screen, press **Phone**.
 - On the steering wheel, press the Call button.
- 2 On the Bluetooth Call screen, press .

3 After entering a phone number, press .

A call is connected to the entered phone number.

-  When contacts are on the system, search for the desired contact by entering the initial letters or number on the dial pad. (e.g. John Doe ► JD).

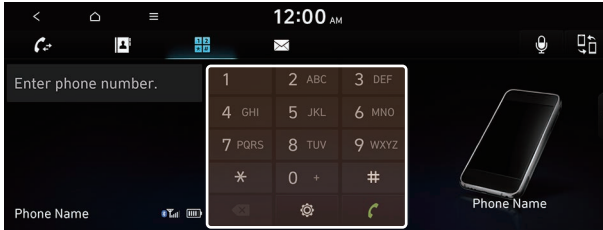

-  Learn more about receiving calls while using Bluetooth connection. ► See "Accepting an incoming call over Bluetooth."

Dial pad screen

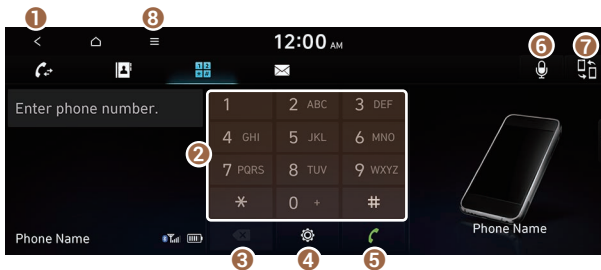

- 1 Returns to the previous step.
- 2 Use the dial pad to enter phone numbers.
- 3 Delete an entered number.
- 4 Can configure the Bluetooth connection settings.
- 5 Press to dial the number you entered.

-  If you have recent calls stored on your system, you can use the following feature before entering a phone number.
 - Pressing this button will display the most recently dialed numbers in the field.
 - Press and hold this button to automatically call the most recently dialed number.

- 6 Make a phone call using voice recognition. ► See "Dialing with voice recognition."
- 7 Find and connect other Bluetooth devices.
- 8 The list of menu items appears.
 - **Display Off:** Turns off the screen. To switch the screen back on, press the screen or briefly press the power button.
 - **Privacy Mode:** Activate privacy mode to protect personal data. The data downloaded from the mobile phone stays hidden while this mode is on.
 - **Change Device:** Find and connect other Bluetooth devices.
 - **Device Connections Settings:** Can change the Bluetooth settings.
 - **User's Manual on Web (QR Code):** Displays the QR code that provides access to the online user manual for the system.
 - **Split Screen:** Can turn on or off the split screen mode.

Dialing with voice recognition

When you connect your mobile device to the system via Bluetooth, contacts from the device are downloaded to the system, and you can choose to call them using voice recognition.

✍ To call using voice recognition, there must be contacts stored on the system.

1 Perform any of the following methods:

- On the All Menus screen, press **Phone**.
- On the steering wheel, press the Call button.

2 On the Bluetooth Call screen, press .

3 When a guiding beep is heard, say the name of the contact to make a phone call.

The system dials the selected contact.

✍ In case of the dial pad screen, press  say the phone number to make a call.

Accepting an incoming call over Bluetooth

The system screen alerts you when you receive a call while connected using Bluetooth.

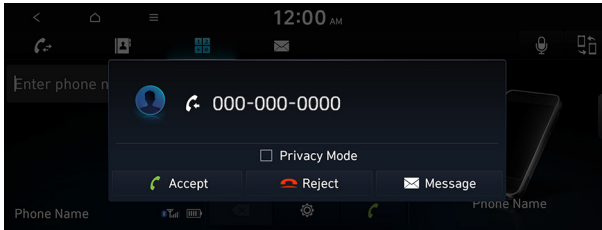

Perform any of the following methods:



- Press **Accept** on the screen.
- On the steering wheel, press the Call button.

Warning

- Park the vehicle at a safe place before connecting your mobile phone. It may take the driver attention off the road and cause a traffic accident which can result in damages, injuries, and/or death.
 - Do not talk on your mobile device while driving. Distraction by the use of a mobile phone may cause you not to recognize traffic flow around and not to cope with unexpected situations. As a result, a traffic accident may occur. If necessary, use the Bluetooth hands-free function and make the call as short as possible.
-  If your mobile phone is connected to the system and you make a call while stepping out of the vehicle, the call may be heard through the vehicle's speakers. To disconnect the call, disable the Bluetooth connection on the system or turn off the Bluetooth function on the mobile phone.

Rejecting a call

Perform any of the following methods:

- Press **Reject** on the screen.
 - On the steering wheel, press the End Call button (if equipped).
 - On the steering wheel, press and hold the Call button (if equipped).
-  To reject by sending a call-reject message, press **Message**. From the list, select the call-reject message and press **Send**.
-  The call-reject or auto-reply message may not be supported in some phone models.

Using functions during a call

During a call, the following screen appears.

Press to use the available options.

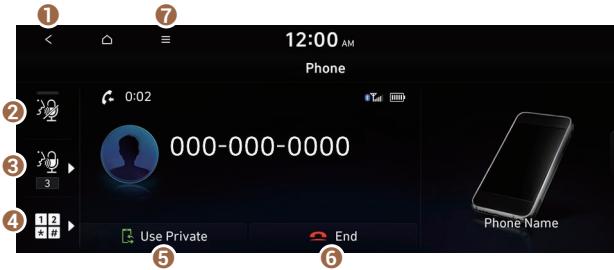

- 1 Returns to the previous step.
- 2 Used to turn on or off the microphone mute function.
- 3 Can adjust the microphone volume.
- 4 Displays or hides the dial pad screen.
- 5 Used to switch the call to the mobile phone. This option may not be available in some phone models.
- 6 Used to end a call.
- 7 The list of menu items appears.
 - **Display Off:** Turns off the screen. To switch the screen back on, press the screen or briefly press the power button.
 - **Privacy Mode:** Activate privacy mode to protect personal data. The data downloaded from the mobile phone stays hidden while this mode is on.
 - **Split Screen:** Can turn on or off the split screen mode.

- ✍ If you set the microphone volume too high, the other party may have a difficulty understanding you due to noise or echoing, depending on their mobile phone and surroundings. Setting the volume to 30 or lower is recommended.
- ✍ When the caller is in the contact list, the caller's name and phone number of the caller are displayed. Otherwise, only the phone number appears.
- ✍ During a call with a Bluetooth connection, you cannot switch to another screen such as Radio/Media mode.
- ✍ Depending on the phone model, the call volume of the other party may differ.
- ✍ Depending on the phone model, the smartphone number may not appear.

Switching to another call

You can receive another incoming call while in a call. This option is available only when the connected mobile phone supports the call hold function. The original call is put on hold.

To switch between two calls, use either option.

- Press **Switch**.
- Press a displayed phone number.

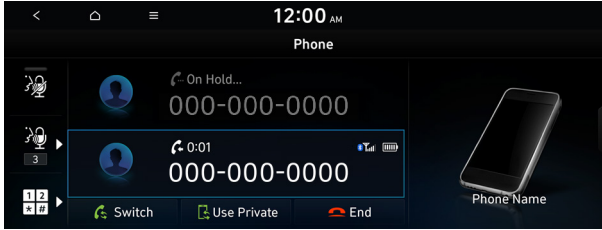

 This option may not be available in some phone models.

Checking new messages over Bluetooth

After connecting a mobile phone via Bluetooth, you can check the received messages through the system screen and listen to voice messages converted from the text messages. This option is available when a mobile phone is connected via Bluetooth. You can also send the brief reply message registered in the system.

Checking new messages

When a message is received, the new message notification window appears.

To check the message, press **View**.

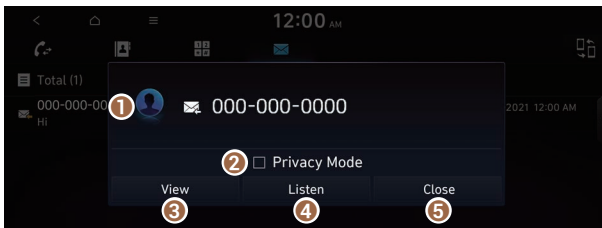

- 1 View caller details.
- 2 Activate privacy mode to protect personal data. The data downloaded from the mobile phone stays hidden while this mode is on.

- ③ Can see the message details.
 - ④ Reads out the message through the speakers in the vehicle.
 - ⑤ Used to close the notification window.
- ✍ The message notification window does not appear when the privacy mode is enabled or the message notification is turned off.
- ✍ The screen display may differ depending on the mobile phone model.

Bluetooth message screen

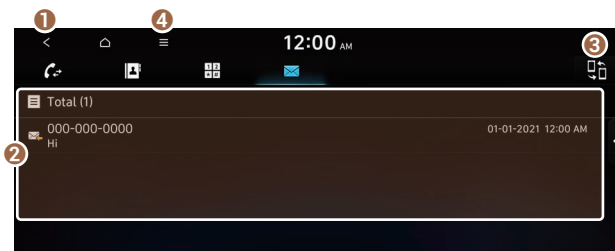

- ① Returns to the previous step.
- ② View the list of received messages.
- ③ Find and connect other Bluetooth devices.
- ④ The list of menu items appears.
 - **Display Off:** Turns off the screen. To switch the screen back on, press the screen or briefly press the power button.
 - **Privacy Mode:** Activate privacy mode to protect personal data. The data downloaded from the mobile phone stays hidden while this mode is on.
 - **Change Device:** Find and connect other Bluetooth devices.
 - **Device Connections Settings:** Can change the Bluetooth settings.
 - **User's Manual on Web (QR Code):** Displays the QR code that provides access to the online user manual for the system.
 - **Split Screen:** Can turn on or off the split screen mode.

Checking new messages from the list

- 1 Perform any of the following methods:
 - On the All Menus screen, press **Phone**.
 - On the steering wheel, press the Call button.
- 2 On the Bluetooth Call screen, press .
- 3 Select a message from the list.
- 4 Check the message.

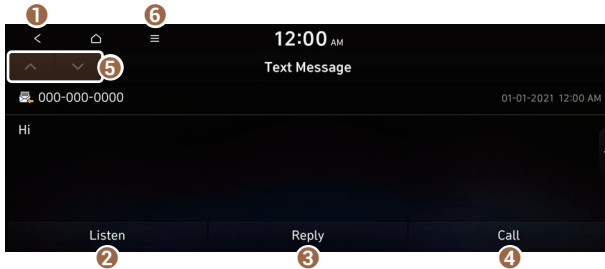

- 1 Returns to the previous step.
- 2 Reads out the message through the speakers in the vehicle.
- 3 Used to select a message registered in the system for sending a brief reply message.
- 4 Used to make a call to a message sender.
- 5 Used to move to the previous or next message.
- 6 The list of menu items appears.
 - **Display Off:** Turns off the screen. To switch the screen back on, press the screen or briefly press the power button.
 - **Split Screen:** Can turn on or off the split screen mode.

- ✍ The auto-reply messaging may not be available depending on the smartphone model.
- ✍ To edit or delete a message, park the vehicle at a safe place and access the messaging function on your smartphone. You cannot edit or delete a message from the system.
- ✍ When an iPhone is connected to the system, there are some restrictions when receiving messages as follows:
 - Only the sender name appears when the sender information is saved.
 - When the sender information is not saved, only the phone number appears.
 - You cannot use the auto-reply message function.
 - When the incoming message notification or lock-screen view option is off, messages cannot be received.
- ✍ The message reader function may not be supported depending on the system language.

07

Voice functions

Voice recognition

Using the Siri Eyes Free

Voice Memo



Voice recognition

With the voice recognition function, you can access various functions of the infotainment system without manipulating the screen or buttons. This function prevents driver distraction and dangerous situations.

Use voice commands to access various functions easily.

- ✍ The system can recognize the specified voice commands. ► See "[Available voice commands](#)" or "[Viewing the voice recognition help](#)."
- ✍ Note the following for accurate delivery of command when saying it.
 - Pronounce a command accurately and naturally like a conversation.
 - Keep the correct posture and say commands toward the direction of the microphone.
- ✍ Voice recognition is automatically ended when:
 - You make or receive a call.
 - The front or rear cameras operate (if equipped).
 - The **[RADIO]** or **[MEDIA]** button is pressed to perform another function.
 - Rerouting or other unexpected action is made due to deviation from the route during guidance.
- ✍ Voice recognition may not work properly when:
 - The sunroof or windows are open so the wind is strong.
 - The fan speed of the air conditioner or heater is high (level 3 or below is recommended).
 - The vehicle is passing through a tunnel.
 - The vehicle is driving on an unpaved road and its noise and vibration are loud.
 - Noise is loud due to a heavy rain or storm.

Using the voice recognition function

1 On the steering wheel, press the Voice Recognition button.

Voice recognition starts along with voice guidance.

 To skip the voice guidance, press the Voice Recognition button on the steering wheel.

2 When a beep sound is heard, say a command to perform (e.g. navigation, music, call). ► See "Available voice commands" or "Viewing the voice recognition help."

The recognized command appears in text at the top of the screen and the corresponding function is performed.

 When an additional command is required to perform, the commands that can be followed in the next step appear on the screen. Say a command or press a command.

 When there are several similar commands, say a command number to perform.

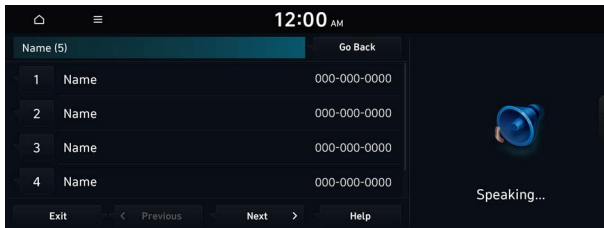

3 To end the voice recognition, perform one of the following methods:

- In standby mode for voice recognition, say "Exit".
- On the voice recognition screen, press **Exit**.
- On the steering wheel, press and hold the Voice Recognition button.

 When the Voice Recognition button is pressed in standby mode for voice recognition, the standby time is extended.

 When the voice recognition is not available, press the Voice Recognition button on the steering wheel and use the voice recognition on your smartphone via phone projection. ► See "Using the phone projection function."

Voice recognition screen

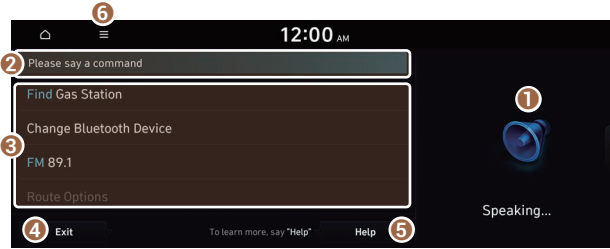

- 1 According to voice recognition, the icons for voice recognition, voice guidance, and command process appear.
- 2 The recognized voice command appears in text.
- 3 Shows the representative voice command.
- 4 Ends the voice recognition.
- 5 Displays the voice recognition help.
- 6 The list of menu items appears.
 - **Split Screen:** Can turn on or off the split screen mode.

Adjusting the voice guidance volume

Adjust the voice guidance volume when the system volume is so low or high and it interferes with your driving.

When the voice recognition is active, use the Volume knob/button on the control panel.

Viewing the voice recognition help

You can see more details on how to perform various functions by voice commands.



Caution

Park the vehicle at a safe place and see the help.

1 On the steering wheel, press the Voice Recognition button.

2 Say "Help".

 When the mode time exceeds before you speak, you can press **Help** instead.

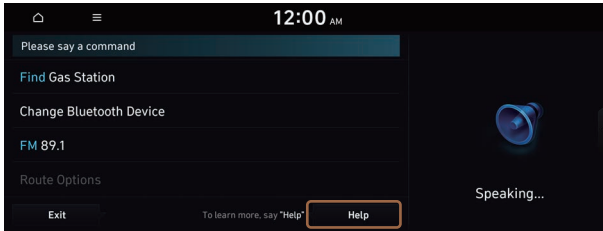

3 Select the desired option and see its help.

- To see the entire help for use of voice commands, press  at the bottom of the screen.

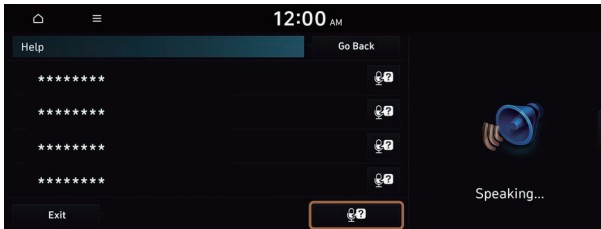

- To see more details on how to use voice commands for each function, press  next to the function name.

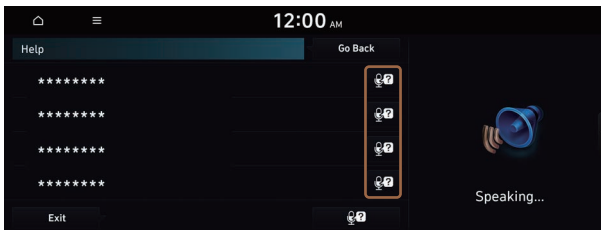

4 After seeing the help, perform any of the following methods.

- On the help screen, press **Exit**.
- In standby mode for voice recognition, say "Exit".

Voice recognition Help

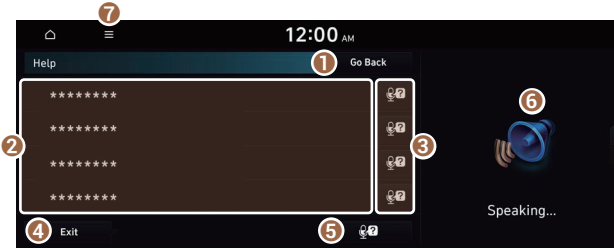

- 1 Returns to the previous step.
- 2 The function list appears.
 - ✎ To see the list of voice commands that can be used for each function, press or say the function.
- 3 You can see the usages for each function.
- 4 Ends the voice recognition.
- 5 You can see the entire help for use of voice commands.
- 6 According to voice recognition, the icons for voice recognition, voice guidance, and command process appear.
- 7 The list of menu items appears.
 - **Split Screen:** Can turn on or off the split screen mode.

Available voice commands

Call commands

Command	Function
Call	You can make a call to one of your mobile phone's contacts. Say a contact's name to begin a call.
Call <Name>	The system dials the phone number of that contact. If the contact has multiple phone numbers, select a phone number.
Call <Name> on Mobile	The system dials the phone number saved as "Mobile" for that contact.
Call <Name> at Work	The system dials the phone number saved as "Work" for that contact.
Call <Name> at Home	The system dials the phone number saved as "Home" for that contact.
Call <Name> on Other	The system dials a phone number saved as other than "Mobile", "Work", or "Home" for that contact.
Dial Number	You can make a call. Say a phone number to begin a call.
Dial <Phone #>	You can make a call immediately to that phone number.
Change Bluetooth Device	You can search for and connect another Bluetooth device.

 To use call commands, your mobile phone must be connected to the system via Bluetooth and your contacts must be downloaded. ► See "[Connecting a Bluetooth device.](#)"

 Some functions may not be available, depending on the connected mobile phone.

Navigation commands

Command	Function
Find Address in <State>	You can search for a location with its address in a designated state. Say an address in order of the house number, street, and city.
Find <POI>	You can search for a designated category of POIs nearby. ► See "POI names."
Freq. visited points	You can select a location from the list of your frequently visited points. Say the number of the location you want.
Saved Places	Access the Saved Places screen.
Destinations	You can select a location from the list of your previous destinations. Say the number of the location you want.
Searches	You can select a destination from the list of destinations that have recently been searched for. Say the number of the location you want.
Traffic Information	Access the traffic information screen.
Go Home	Set the location saved to the Home shortcut button in your address book as your destination.
Go to Work	Set the location saved to the Work shortcut button in your address book as your destination.
Change Home	You can change the location saved as your home.
Change Work	You can change the location saved as your work.
Pause Route	Pause the navigation guidance.
Resume Route	Resume the navigation guidance.
Turn Guidance On	Unmute the navigation guidance.
Turn Guidance Off	Mute the navigation guidance.
Cancel Route	Stop the navigation guidance and cancel your current destination.
Destination Information	View information on the distance and time to your current destination.
Route Options	Find another route.
Show Route	View the entire route on the map.

- ✍ When you use a command starting with "Find," the system searches for locations within the state or province where your vehicle is currently located. To search for locations in another state or province, say the state or province name first and then say the location you want.
- ✍ Some commands, such as "Cancel Route" or "Show Route," are available only when a destination is set.

Radio commands

Command	Function
FM <87.5 to 107.9>	Turn on the FM radio with that frequency.
AM <530 to 1710>	Turn on the AM radio with that frequency.
SiriusXM <0 to 999>	Turn on the SiriusXM radio with that channel number.

Rear-seat function commands (if equipped)

Command	Description
Passenger Talk	Turn on the Passenger Talk.
Quiet Mode	Turn on or off the Quiet Mode.
Turn off Quiet Mode	

- ✍ Some commands may not be supported, depending on the vehicle model and functions.

Search commands

Command	Function
Search settings for <Settings menu>	You can search for a setting menu. For example, say "Search settings for Bluetooth" or "Search settings for Display." ► See "Configuring system settings."

Other commands

Command	Function
Help	Move to the help screen.
Line <1 to 4>*	Select an item with the designated number on a list. Simple numbers, such as "One" or "Two," can be recognized.
Yes*	Accept a notification asking for your confirmation in an exceptional situation.
No*	Deny a notification asking for your confirmation in an exceptional situation.
Next*	If there are more than five items on a list, scroll to the next page.
Previous*	If you scroll to the next page of a list, scroll back to the previous page.
Manual Input*	When using the Dial Number command, open the keypad to enter a phone number manually.
Go Back*	Returns to the previous step.
Exit	End voice recognition.

* These commands are available only in certain situations.

POI names

Restaurants

POI name

Fast Food

Arby's

Boston Market

BURGER KING

Carl's Jr

Chick-fil-A

Chipotle

Church's Chicken

Dairy Queen

Firehouse Subs

Hardee's

IHOP

In-N-Out Burger

Jack in the Box

Jimmy John's

KFC

Little Caesars

Long John Silver's

McAlister's Deli

McDonald's

Panda Express

Panera Bread

Popeyes

Quiznos Sub

Schlotzsky's

SONIC

SUBWAY

Taco Bell

Taco John's

Waffle House

POI name

Wendy's

White Castle

Blimpie

Checkers

Culver's

Five Guys Burgers and Fries

Jersey Mike's Subs

Steak n Shake

Whataburger

Coffee Shops

Starbucks

Dunkin' Donuts

Tim Hortons

Baskin-Robbins

Cold Stone Creamery

Jamba Juice

Smoothie King

American

Applebee's

Bahama Breeze

Boston's Restaurant & Sports Bar

Cheeseburger in Paradise

Chili's Grill & Bar

Cool River

Denny's

Frisch's Big Boy

Good Eats

III Forks

Lee Roy Selmon's

Lone Star Steakhouse

Longhorn Steakhouse

Luckys Cafe

Outback Steakhouse

POI name
Ponderosa
Publix
Seasons 52
Sheetz
Silver Fox
Texas Roadhouse
TGI Friday's
The Capital Grille
A&W
Bob Evans
Buffalo Wild Wings
Cracker Barrel Old Country Store
Golden Corral
Red Robin
Ruby Tuesday
Wingstop
Fleming's
Italian
Bonefish Grill
Carrabba's Italian Grill
Chuck E Cheese's
Domino's
Olive Garden
Papa John's
Papa Murphy's
Pizza 73
Pizza Hut
pizza pizza
Cici's Pizza
Godfather's
Hungry Howie's Pizza
Marco's Pizza

POI name
Latin American
Mexican
Cantina Laredo
Chevys
El Chico
Del Taco
Moe's Southwest Grill
Qdoba
Toks
Asian
Chinese
PF Chang's China Bistro
Japanese
Korean
Seafood
Red Lobster
Captain D's
Vegetarian Food
French
Continental
African
Others
Auntie Anne's
Haagen-Dazs
Hooters
Roy's
TCBY
VAN DER VALK
Bojangles'
Zaxby's

Automotive

POI name
Hyundai Dealerships
Gas Stations
76
ampm
ARCO
BP
Gas+
Casey's General Store
Cenex
Chevron
CITGO
Conoco
Esso
Exxon
Fleetfuels
GetGo
Giant Gasoline
Gulf
Husky
Ingles Gas Express
Marathon
Martin's Gasoline
Meijer Gas Station
Mobil
Murphy Express
Murphy USA
Petro Stopping Centers
PETRO-CANADA
Phillips 66
Pioneer
QuikTrip

POI name
Rutter's
Sheetz
Shell
Sinclair
Speedway
Sunoco
TEXACO
TravelCenters of America
Ultramar
Valero
Wawa
Hess Express
Irving
Pemex
7-Eleven
Costco
Parking
Parking Garage
Open Parking Area
Park & Ride
Auto Services
AAA
Advance Auto Parts
America's Tire
AutoZone
BOSCH Car Service
Canadian Tire
Certigard
Chevron
CITGO
Discount Tire
Exxon

POI name
Firestone
GOODYEAR
Gulf
Jiffy Lube
Kal Tire
Midas
Mobil
Napa
O'Reilly Auto Parts
PETRO-CANADA
Sears Auto Center
Shell
TEXACO
AAMCO Transmissions
ACDelco
Big O Tires
CARQUEST
Meineke Car Care Center
Monro Muffler Brake & Service
Napa Autocare Center
Pep Boys
Quick Lane
Safelite AutoGlass
Tires Plus
Valvoline Instant Oil Change
Roadside Assistance
Auto Parts
Car Washes
Automobile Dealerships
Motorcycle Dealerships
EV Charging Stations
ChargePoint
EVgo
Blink

POI name
SemaConnect
Greenlots
Electrify America
FLO
Hyundai Service

Travel

POI name
Airports
Hotels
Americas Best Value Inn
AmericInn
Andaz
Ascend Collection
Baymont Inn & Suites
Best Western
Cambria Suites
Canadas Best Value Inn
Candlewood Suites
Clarion Hotel
Comfort INN
Comfort Suites
CONRAD
Country Inn & Suites by Carlson
COURTYARD by Marriott
Crowne Plaza
Days Inn
DELTA
Doubletree
Econo Lodge
Embassy Suites
Grand Residences by Marriott
Hampton Inn
Hawthorn Suites

POI name
Hilton
Hilton Garden Inn
Hilton Grand Vacations
Holiday Inn
Holiday Inn Express Hotel & Suites
Homewood Suites
Hotel Indigo
Howard Johnson
Hyatt Place
Hyatt
Hyatt Summerfield Suites
Intercontinental
JW Marriott
La Quinta Inn & Suites
Lexington
Mainstay Suites
Marriott
Marriott VACATION CLUB
Microtel Inns & Suites
Motel 6
NOVOTEL
Omni Hotels
Park Inn
Park Plaza
QUALITY INN
Radisson
RAMADA
Red Roof Inn
Regent Hotels & Resorts
Renaissance
Residence Inn
Ritz-Carlton

POI name
Rodeway Inn
Sheraton
Sleep Inn
SOFITEL
Staybridge Suites
Studio 6
Suburban Extended Stay
Super 8
Thriftlodge Canada
Travelodge
Travelodge Canada
WALDORF ASTORIA COLLECTION
Wingate by Wyndham
Wyndham
Extended Stay America
Fairfield Inn by Marriott
SpringHill Suites by Marriott
Towneplace Suites
WESTIN
FOUR POINTS BY SHERATON
Aloft
ST. REGIS
Le MERIDIEN
AC
Ritz-Carlton Club
Best Western PLUS
Best Western PREMIER
Tryp
Rental Car Agencies
Alamo
AVIS
Budget

POI name
Dollar Rent A Car
Enterprise
Hertz
National
Thrifty
Tourist Information
Tourist Attractions
Travel Agents
Rest Areas
Complete Rest Area
Parking and Rest Room Only
Parking Only
Motorway Service Area
Scenic Overlook
Truck Stop/Plaza
City Centers
Campgrounds
Ferry Terminals
Bus Stations
Local Transit
Railway Station
Commuter Rail Station

Shopping

POI name
Department Stores
Canadian Tire
Dollar General
Dollar Tree
Family Dollar
JCPenney
Kmart

POI name
Kohl's
Nordstrom
Sears
Sears Hometown Store
Target
T.J. Maxx
Walmart
Big Lots
Macy's
Marshalls
Ross Dress For Less
Convenience Stores
7-Eleven
ampm
BP
Circle K
Fleetfuels
GetGo
Kangaroo Express
Murphy Express
Murphy USA
Petro Stopping Centers
QuikTrip
Rutter's
TravelCenters of America
Wawa
Cumberland Farms
Hess Express
Mac's
Mini Mart
Quick Stop
Valero Corner Store

POI name

Shopping Centers

Grocery Stores

Giant Eagle

Giant Food Stores

IGA

Ingles Markets

Food Lion

Kmart

Kroger

Martin's Food Markets

Meijer

Publix

Sav-Mor Foods

Save-A-Lot

SuperValu

Albertsons

ALDI

Piggly Wiggly

Safeway

Winn-Dixie

Pharmacies

CVS/pharmacy

Giant Drugstore

Giant Eagle

Ingles Pharmacy

Kmart Pharmacy

Kroger Pharmacy

Martin's Drugstore

Meijer Pharmacy

Publix

Rite Aid

Shoppers Drug Mart

POI name

Walgreens

Medicine Shoppe

Safeway

Sam's Club

Electronics

AT&T

Best Buy

GameStop

Radioshack

Sprint

Staples

T-Mobile

OfficeMax

US Cellular

Verizon

Boost Mobile

Cricket Wireless

metroPCS

Home Specialty Stores

ABC Fine Wine & Spirits

Ace Hardware

Claire's

Costco

Home Depot

Lowe's

Merle Norman

PETCO

PETSMART

Sally Beauty Supply

SHERWIN-WILLIAMS

True Value

Bath & Body Works

POI name

BED BATH & BEYOND

Carpet One

Do It Best

Family Video

GNC

HOBBY LOBBY

Home Hardware

Jo-Ann

Michaels

Party City

Pier 1 Imports

Sam's Club

SEPHORA

Sleepy's

Sunglass Hut

Toys"R"Us

Tuesday Morning

Sporting Goods

Dick's Sporting Goods

Sports Authority

HIBBETT SPORTS

Music Stores

Bookstores

Barnes & Noble Booksellers

Gifts

Clothing

Mark's

Aeropostale

American Eagle Outfitters

Cato

Chico's

POI name

Children's Place

Dressbarn

Famous Footwear

Finish Line

Foot Locker

GAP

Gymboree

Hot Topic

Journeys

Justice

Lane Bryant

Men's Wearhouse

Old Navy

PacSun

Rainbowshops

rue21

Victoria's Secret

Shoe Stores

Payless Shoesource

General Merchandise

Recreation

POI name

Amusement Parks

Museums

Cinemas

Golf Courses

Sports Complexes

Sports Activities

Wineries

Video & Game Rental

POI name
Ski Resorts
Recreation Areas
Other Recreation Areas

Financial Services

POI name
Banks
Bank of America
BB&T
Chase
Citibank
Citizens Bank
Fifth Third Bank
KeyBank
PNC Bank
RBC Royal Bank
Regions
SunTrust
TD Bank
TD Canada Trust
US Bank
Wells Fargo
Bank of the West
BBVA Compass
BMO Bank of Montreal
BMO Harris Bank
Caisse Populaire Desjardins
Capital One
CIBC
First Citizens Bank
First National Bank

POI name
M&T Bank
Santander
Scotiabank
The Huntington National Bank
Woodforest National Bank
ATMs
Bank of America
BB&T
Chase
Citibank
Citizens Bank
Fifth Third Bank
KeyBank
PNC Bank
RBC Royal Bank
Regions
SunTrust
TD Bank
TD Canada Trust
US Bank
Wells Fargo
Bank of the West
BMO Bank of Montreal
BMO Harris Bank
Caisse Populaire Desjardins
Capital One
CIBC
Commerce Bank
First National Bank
HSBC
M&T Bank

POI name
Santander
Scotiabank
State Employees' Credit Union
Check Cashing Services
Money Transfer

Community

POI name
Police Stations
Post Offices
Libraries
Schools
Fire Departments
Convention Centers
Churches
Synagogues
City Halls
Civic Centers
Court Houses
Government Offices
Waste & Sanitary
Utilities
Business Facilities
Hyundai Motor Company
Hyundai MOBIS
Hyundai AutoEver
HMG Affiliates
Hyundai Steel
Hyundai TRANSYS
Hyundai GLOVIS
Hyundai Engineering
Hyundai Rotem
INNOCEAN WORLDWIDE

Services

POI name
Hospitals
Medical Services
Physicians
Tax Services
Attorneys
Funeral Homes
Hair & Beauty
Cleaning & Laundry
Social Services
Communication
Dentists
Photography
Tailors & Alterations
Movers
Nursing Homes
Optical
Personal Services
Repair Services
Veterinary Hospitals
Shipping Centers

 Available POI names may change when the system is updated.

Using the Siri Eyes Free

When you connect an Apple device that is compatible with Siri to your system via Bluetooth, you can use the Siri Eyes Free. This allows you to perform the functions on your system and Apple device with voice commands so that you can devote your attention to driving.

First, make sure that your Apple device supports Siri and that you have activated Siri.

- 1 Connect your Apple device to your system via Bluetooth.
- 2 On the steering wheel, press and hold the Voice Recognition button.
- 3 On the Siri screen, press **Speak**.

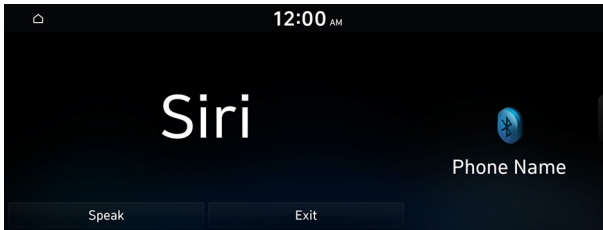

- 4 Say a command.
 - ✎ You can perform the functions related to Bluetooth calls on the system and other functions on your Apple device.
 - ✎ Press the Voice Recognition button to restart Siri.
- 5 To end Siri, press and hold the Voice Recognition button on the steering wheel.
 - ✎ Apple devices may have different functions enabled and may vary in the way how they respond to Siri commands, depending on the device type and iOS version.

Voice Memo

You can use the microphone on the vehicle to record and play voice memos.

Running the voice memo

On the All Menus screen, press **Voice Memo**.

Voice memo screen

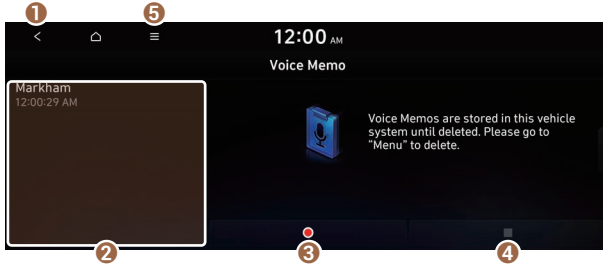

- 1 Returns to the previous step.
- 2 Displays the list of recorded voice memos.
- 3 Starts or pauses the recording.
- 4 Stops recording.
- 5 The list of menu items appears.
 - **Display Off:** Turns off the screen. To switch the screen back on, press the screen or briefly press the power button.
 - **Delete:** Can delete a voice memo.
 - **Save to USB Device:** Can record a voice memo to a USB storage device. Check that the USB device is compatible. ► See "[USB storage devices](#)."
 - **Storage Information:** Can see the file size of recorded voice memos.
 - **User's Manual on Web (QR Code):** Displays the QR code that provides access to the online user manual for the system.
 - **Split Screen:** Can turn on or off the split screen mode.

Recording a voice memo





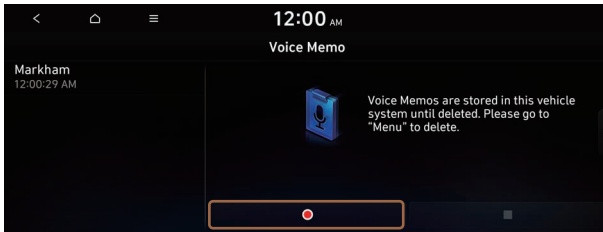

- 1 On the **Voice Memo** screen, press .

It starts recording a voice memo.



- 2 When recording is finished, press  on the screen or press the End Call button on the steering wheel.

The voice memo is automatically saved.

-  To adjust the recording sound volume during voice recording, drag the control bar.
-  To temporarily stop recording, press .
-  When recording starts, the other audio functions are muted or playback is paused.
-  When you make or receive a call while recording, the recording is paused.
-  When you make an emergency call or you are connected to an emergency call after airbag deployment, the recording is stopped and the recorded voice memo is automatically saved.

Playing a voice memo

You can select and play a recorded voice memo.

From the list of Voice Memos, press the desired voice memo.

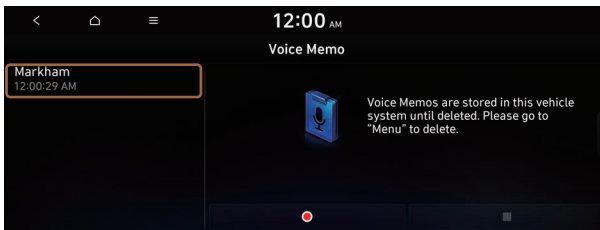

MEMO

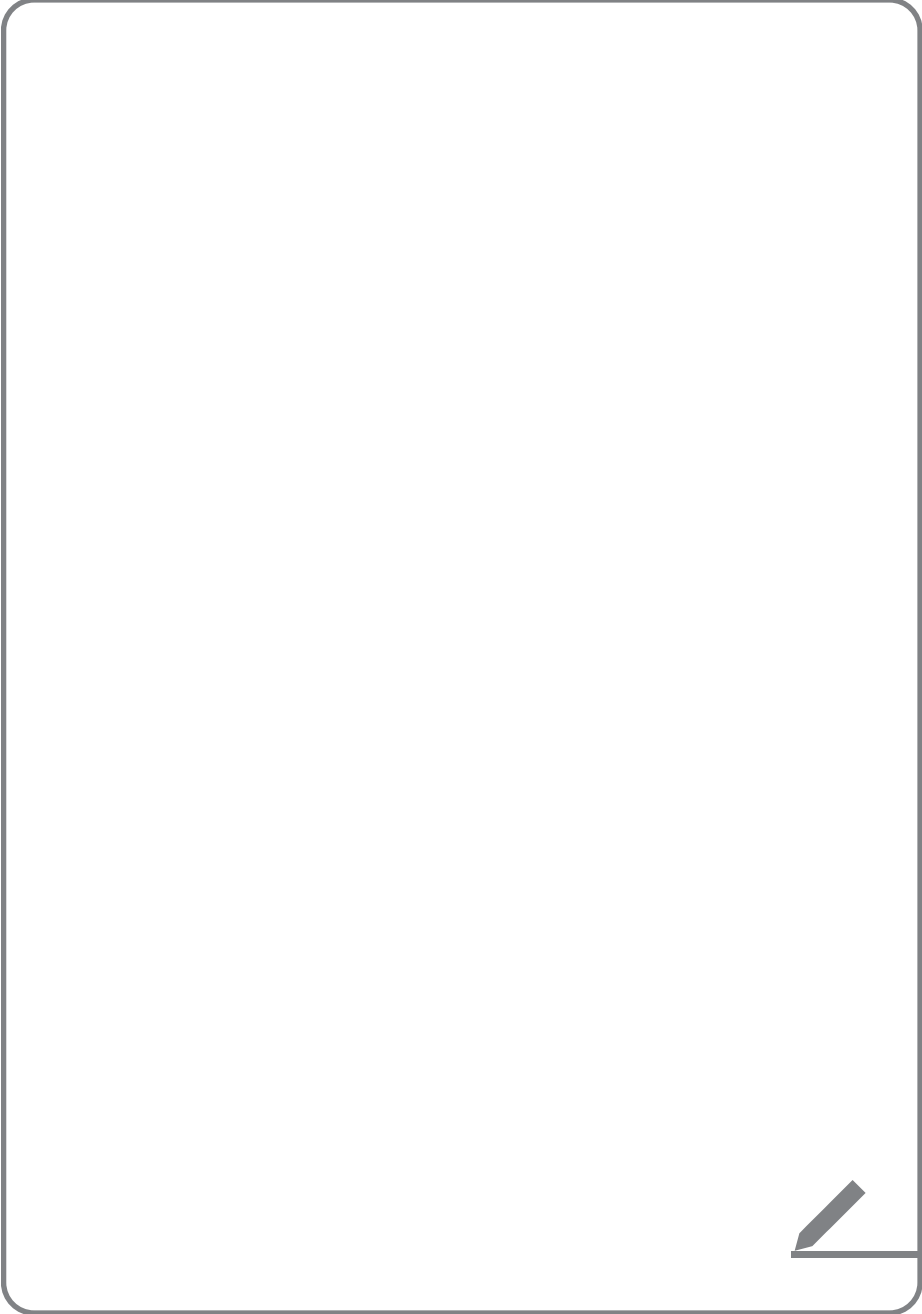

08

Bluelink

Bluelink service

Running the Bluelink menu

Using safety and security services

Route guidance service

Duties Upon Sale or Transfer of Vehicle



Bluelink service

Bluelink provides connected car services, such as roadside assistance and emergency rescue, via the latest IT and communication technologies.

When you have subscribed to Bluelink, you can access Bluelink services through the buttons on the vehicle. You can also access other useful features through Bluelink menus on the system.

- ✍ You must be an active Bluelink subscriber or within the initial free trial period to receive Bluelink services, including Auto Collision Notification.
- ✍ Depending on the conditions such as vehicle type, system type, and the subscribed service package, available services may differ.
- ✍ Some services may incur additional charges.
- ✍ Services may be modified, added, or deleted by changes in the company's policies.

Service restrictions

Bluelink services are provided via the mobile communication network. Accordingly, the service may be restricted depending on the mobile communication network condition. Use the network signal strength icon () at the top of the screen to check the mobile communication status.

- ✍ It is recommended to use the service when the number of signal bars in the icon is 4 or more.
- ✍ Depending on the network signal status, access to Bluelink may be restricted in the following locations:
 - Inside a building or tunnel
 - Mountain or forest area
 - Road close to a cliff
 - Area densely populated with tall buildings
 - Road under expressway or multi-level road
 - Communication shadow area according to the service provider's network coverage policy

Subscribing to the service

You must activate Bluelink service to use it on the system. An account with <https://www.mybluelink.ca> is required to activate the service. When you do not have an account, create a new account to activate the service. When you already have an account, enter your account information registered on <https://www.mybluelink.ca>.

Caution

Do not turn off the vehicle while the activation is in progress. It may cause a system malfunction.

1 Park your vehicle in a safe place.

 You cannot enter information for service activation while your vehicle is moving.

2 On the All Menus screen, press **Bluelink ► Bluelink Settings ► Feature Enrollment**.

3 Follow the on-screen instructions to complete activation.

4 Enter your email address and password.

 When you have a registered account, press Existing Account and enter your email address and password.

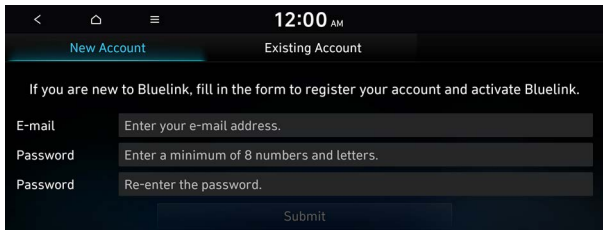

5 Press **Submit**.

 While the activation is in progress, the system buttons are locked.

 If activation fails, contact the Hyundai Customer Relations Center at 1-844-258-5656.

 This activation only allows you to use safety features, such as roadside assistance and emergency services. To use the full services provided by Bluelink, visit <https://www.mybluelink.ca> and complete your profile.

 When your Bluelink service expires, you can reactivate the service by renewing your subscription on <https://www.mybluelink.ca> and entering your email address and password again in the **Feature Enrollment** menu.

Running the Bluelink menu

You can run the Bluelink in the system to use the service.

On the All Menus screen, press **Bluelink**.

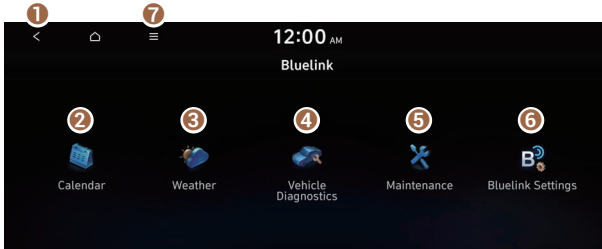

- 1 Returns to the previous step.
- 2 View the schedule details for today and tomorrow (if equipped). ▶ See "Checking schedule details (if equipped)."
- 3 Can see the weather information (if equipped). ▶ See "Checking weather information (if equipped)."
- 4 Checks your vehicle for abnormal conditions and displays the result. ▶ See "Diagnosing the vehicle."
- 5 See the information about the intervals for the last and next maintenance services (if equipped). ▶ See "Checking maintenance service intervals (if equipped)."
- 6 Access the Bluelink service to use it on the system or check modem information.
- 7 The list of menu items appears.
 - **Display Off:** Turns off the screen. To switch the screen back on, press the screen or briefly press the power button.
 - **User's Manual on Web (QR Code):** Displays the QR code that provides access to the online user manual for the system.

🔗 The screen may differ depending on the vehicle model and specifications.

Warning

Driving while distracted may cause a loss of vehicle control that may lead to an accident, severe bodily injury, or death. The driver's primary responsibility is the safe and legal operation of the vehicle, and the use of any vehicle systems, including the touch screen and steering wheel controls that take the driver's eyes, attention, and focus away from safe driving or that are not permissible by the law, should never be used while driving.

🔗 Use the Bluelink features on the system when the vehicle is stationary with the vehicle turned on.

Checking schedule details (if equipped)

View the schedule details for today and tomorrow.

On the All Menus screen, press **Bluelink** ► **Calendar**.

✍ To use the calendar, make sure you install the Bluelink App on your smartphone and sign up for the Bluelink Service. Use either Google Play Store or App Store (depending on your smartphone model) to download and install the Hyundai Bluelink App and sign up for the Bluelink Service. ► See "Subscribing to the service."

✍ To use the calendar, make sure your user profile is linked to your Bluelink account. It is not possible to use the calendar if your user profile is set to "Guest." To link your user profile to your Bluelink account, press **Setup** ► **User Profile** from All Menus.

Calendar screen

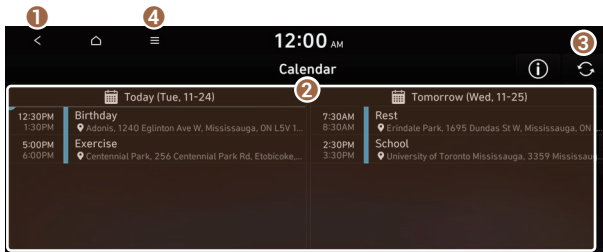

1 Returns to the previous step.

2 View the schedule details for today or tomorrow.

3 Update with the latest schedule details.

4 The list of menu items appears.

- **Display Off:** Turns off the screen. To switch the screen back on, press the screen or briefly press the power button.
- **Sync now:** Sync to the latest schedule details of the linked account.
- **Select Calendar(s):** Select the calendar to display on the screen.
- **User's Manual on Web (QR Code):** Displays the QR code that provides access to the online user manual for the system.
- **Split Screen:** Can turn on or off the split screen mode.

✍ Available icons and their arrangement may differ depending on the vehicle model and specifications.

Setting a destination

You can view schedule details and set a destination by pressing on an event from the calendar screen.

✍ If location information is registered in the schedule, the registered location is automatically set as the destination.

1 From the calendar screen, press on the event to set a destination.

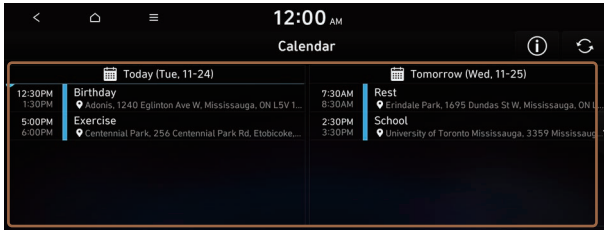

2 Press **Search Destination**.

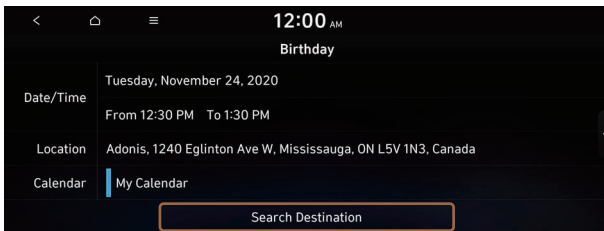

3 Check the location of the destination and then press **Set as Destination**.

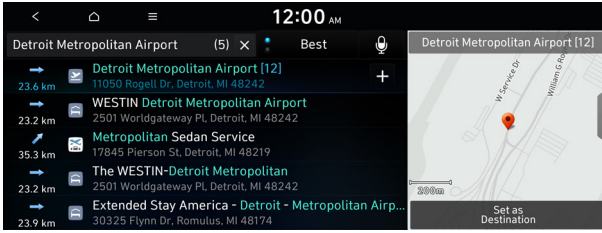

✍ When you see the search result list, press the desired destination to see on the map.

4 Select a route and press **Start Guidance**.

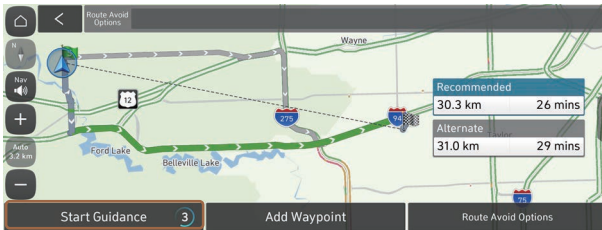

Schedule reminder

A schedule notification pops up at a specified time.

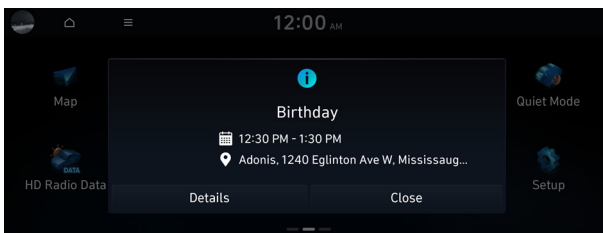

✍ To view schedule details, press **Details**.

Checking weather information (if equipped)

You can see the weather information (temperature, humidity, amount/probability of precipitation, etc.) for today or the next 6 days.

✍ The weather information is accessible only when the system is connected to the network.

On the All Menus screen, press **Bluelink ► Weather**.

Weather information screen

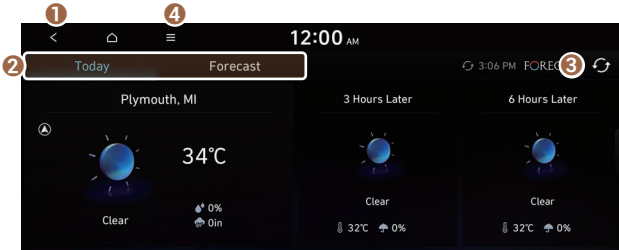

- 1 Returns to the previous step.
- 2 Can see the weather information for today or the next 6 days.
- 3 Can update to the latest weather information.
- 4 The list of menu items appears.
 - **Display Off:** Turns off the screen. To switch the screen back on, press the screen or briefly press the power button.
 - **Current Location:** Displays the weather of the current position.
 - **Waypoint:** Displays the weather of the waypoint, if specified.
 - **Destination:** Displays the weather of the destination, if specified.
 - **Search:** Can see the weather information by searching for an address (if equipped).
 - **Forecast:** Can see the weather information for today or the next 6 days.
 - **User's Manual on Web (QR Code):** Displays the QR code that provides access to the online user manual for the system.
 - **Split Screen:** Can turn on or off the split screen mode.

Diagnosing the vehicle

You can diagnose your vehicle. The information is sent to the Bluelink Center. You can receive the diagnosed result from the representative and use additional services, such as towing, route guidance to a repair shop, or a maintenance reservation.

1 Park your vehicle in a safe place.

 You can start a diagnosis only when the vehicle stops, because some components cannot be diagnosed while the vehicle is moving.

2 On the All Menu screen, press **Bluelink ► Vehicle Diagnostics**.

 A remote diagnosis starts. Refrain from using your system until the diagnosis is complete and the result is displayed on the screen. When you move to another screen while a diagnosis is in progress, the diagnosis is canceled.

3 Check the result displayed on the screen.

 A diagnosis result provided by this service is only an estimated result based on the signals from your vehicle. Visit a Hyundai Motor Company Service Center or a service coordinator for a detailed diagnosis.

Checking maintenance service intervals (if equipped)

You can see information about the intervals for the last and next maintenance services. This feature can help you maintain your vehicle on a regular basis.



1 On the All Menu screen, press **Bluelink ► Maintenance**.

2 Check the maintenance information.

 You can see the distance driven and the number of days remaining before the vehicle should receive maintenance again. Use the information to determine when to perform the next maintenance service.

 To reset the information, press **Reset**.



 To access the online user's manual on the Maintenance screen, press  ► **User's Manual on Web (QR Code)** and then scan the displayed QR code.

Configuring the Bluelink settings

You can subscribe to the Bluelink service or see the modem information.

- 1 On the All Menus screen, press **Bluelink ► Bluelink Settings**.

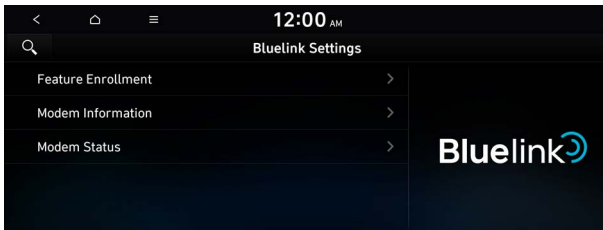

- 2 Select the desired option(s):

- To subscribe to the Bluelink service by using the Bluelink settings menu, press **Feature Enrollment**.
- To check the modem information for use of the Bluelink service, press **Modem Information**.
- To check the modem status for use of the Bluelink service, press **Modem Status**.

Using Voice Local Search (if equipped)

With Bluelink, you can search for locations from the online map database by using voice commands.

If you did not update the map or system or you cannot find your destination in the navigation, you can use the latest information from the online server to search for locations and receive guidance.

- 1 On the steering wheel, press the Voice Recognition button and say "Find + <POI>".
- 2 After the voice guidance ends and you hear a beep, say the POI name or Address.

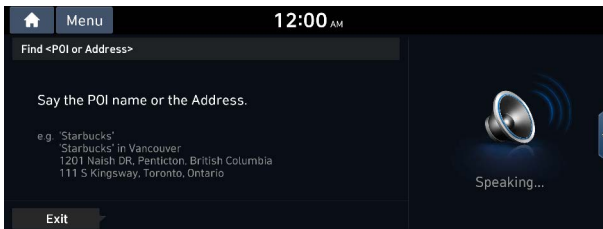

✎ Depending on the system language, voice recognition may not be supported.

Contacting the roadside assistance

When you encounter a disabled vehicle or another problem on the road, you can contact the roadside assistance directly to receive vehicle towing.

Upon any emergency, press the  button on the vehicle.

 When connected to a roadside assist service agency, ask a representative for the service you need.

 To end the call, press the  button.

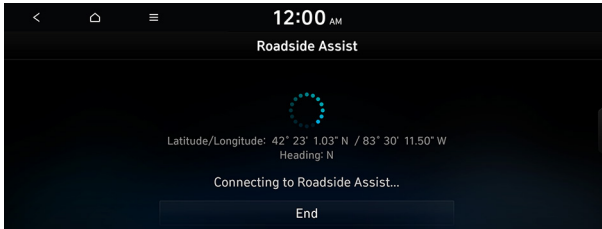

Using safety and security services

Upon emergencies or accidents, you can use various types of assistances.

Auto Collision Notification

This service provides you with immediate assistance when an accident occurs and an airbag is deployed. When this happens, an Auto Collision Notification (ACN) signal, containing your customer and location information, will be transmitted to the Bluelink center automatically.

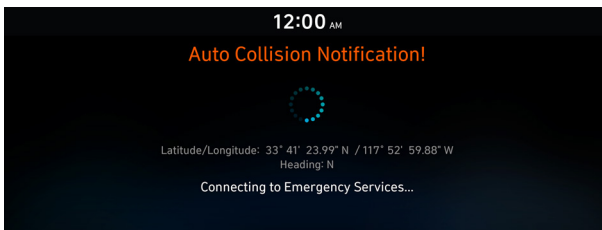

Once the signal has been received, a response specialist establishes voice communications with you and forwards any pertinent information to Bluelink emergency services.

SOS

You can request Bluelink emergency services.

Upon any emergency, press the [SOS] button on the vehicle.

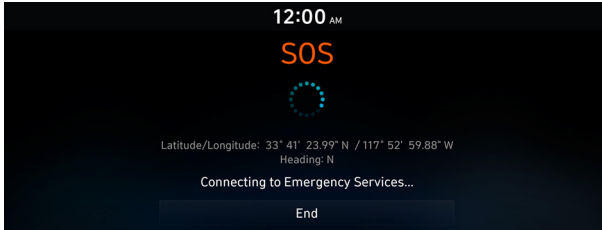

Vehicle information and location are sent to specially trained response specialists, who assist in coordinating the dispatch of appropriate emergency assistance to you.

- ✍ The response specialist will remain connected with you until the first emergency assistance arrives.
- ✍ To end the SOS call, press the [SOS] button.

Route guidance service (if equipped)

Use a more convenient, accurate route guidance service through the Bluelink route guidance service.

Finding a route by manually entering a destination

You can use fast and accurate route guidance based on real-time and forecast traffic data collected by the Bluelink Center.

Using the Bluelink quick route guidance

You can use the quick navigation service based on real-time traffic information analyzed by the Bluelink Center.

- 1 Set the destination on the navigation system.

2 From the list of routes, select the Bluelink route.

Quick route guidance starts by the Bluelink Center.

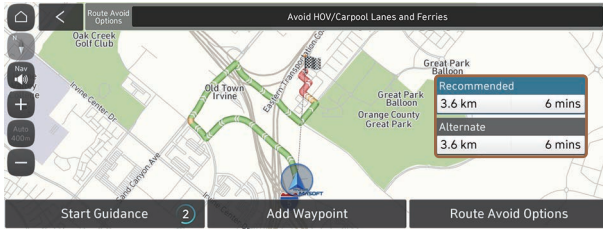

 The screen may differ depending on the vehicle model and specifications.

 You can use the Bluelink route to search for a different route while in route guidance.

 The road information by the Bluelink may differ from actual road conditions. Be sure to drive according to actual road conditions and regulations.

 The estimated time of arrival and remaining time to destination are calculated based on the traffic conditions. The calculated times may differ depending on the change in traffic conditions.

 Depending on the map update time, guidance on a new road may not match actual road conditions.

Guidance to destination service

If you park your vehicle at a distance of more than a specified value away from the destination, you can continue to use the route guidance to the destination from your smartphone.

Duties Upon Sale or Transfer of Vehicle

You must notify us if you plan to sell your vehicle, if your vehicle lease is ending (and you will not be purchasing the vehicle), your rental term is ending or if you are transferring the vehicle to another person for any other reason. You need to notify us so we can take steps to protect your account and your associated personal information. If you fail to notify us, you may be held responsible for any consequences resulting from our being unable to properly protect your account and associated personal information. To notify us, please call Hyundai Canada Customer Relations at 1-844-258-5656 or email us at cr@hyundaicanada.com.

If you sell or otherwise transfer your vehicle, you must cease using any Bluelink services associated with that vehicle, and uninstall the services from any devices in your control. If you fail to do so, you may be held responsible for any claims resulting from such failure brought against us by a subsequent owner, driver, occupant, lessor or lessee of the vehicle or any other third party.

If you have purchased, rented or started a lease of a vehicle with active Bluelink services and your personal information is not in the vehicle's Bluelink system and/or someone else's personal information remains in the Bluelink system, please contact us to prove your ownership, lease or rental (as applicable) in order to change the subscription to your name. Please provide us with your first and last name, postal code and have the vehicle registration available during the call.

09

Settings

- Configuring system settings
 - Configuring the vehicle settings (Type1/Type2)
- Configuring the device connections settings (Type1/Type2)
 - Configuring the advanced system settings (Type1)
 - Configuring the button settings (Type1/Type2)
 - Configuring the sound settings (Type1/Type2)
- Configuring the voice recognition settings (Type1/Type2)
 - Configuring the navigation settings (Type1/Type2)
 - Configuring the Bluelink settings (Type1/Type2)
- Configuring the user profile settings (Type1/Type2)
- Configuring the general system settings (Type1/Type2)
 - Configuring the screen layout settings (Type2)
 - Configuring the display settings (Type1/Type2)
 - Configuring the media settings (Type1)
- How to Update the Map and Software for your Infotainment System



Configuring system settings

Configure various functions required for using the system. View information related to the system.

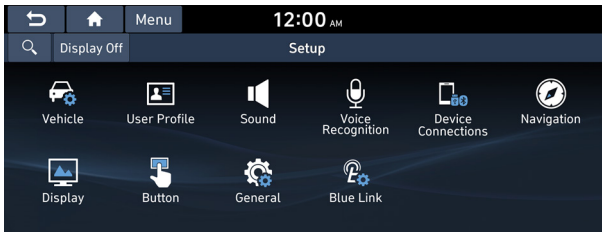

Type1

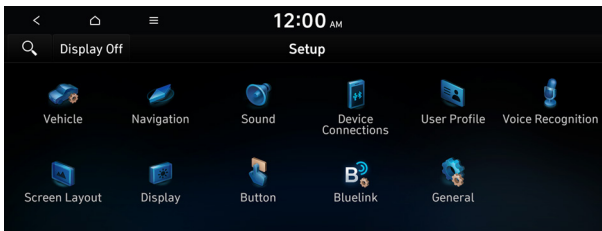

Type2

- ✎ The displayed screen or menu items may differ, depending on the vehicle model and features. Check the screen type for your vehicle model and view the appropriate instructions.
- ✎ Press **Menu** or **☰** ► **Search for Settings** or press **🔍** and enter a keyword to search for a setting item. You can also search for a setting item by voice.
- ✎ If you press **Display Off** at the top of the screen, the screen is switched off. To switch the screen back on, press the screen or briefly press the power button.



Configuring the vehicle settings (Type1)

(if equipped)

You can configure the functions for driving and related environments.

Warning



Make sure you stop the vehicle before changing settings to ensure safety.

-  Vehicle settings can be changed only when the vehicle is on.
-  Available settings may differ depending on the vehicle model and specifications.
-  Depending on the climate control system, some functions may not be supported.

1 On the All Menus screen, press **Setup ► Vehicle**.

The vehicle settings screen appears.

2 Configure the settings required:

-  Press **Menu ► Search for Settings** or press  and enter a keyword to search for a setting item. You can also search for a setting item by voice.

Head-Up Display (if equipped)

You can set to use the head-up display that displays information such as driving speed and road-related information while driving.

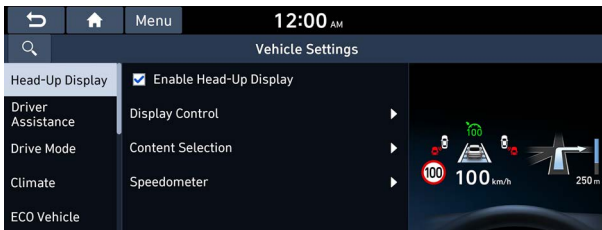

-  The screen may differ depending on the vehicle model and specifications.

Enable Head-Up Display (if equipped)

Can determine whether or not to use the head-up display.

Display Control (if equipped)

Adjust the height, rotation, and brightness of the head-up display.

Content Selection (if equipped)

Select the items to display on the head-up display.

Speedometer (if equipped)

Can set the driving speed items and colors to display on the head-up display.

Driver Assistance (if equipped)

You can set to use various systems that assist the driver for safety.

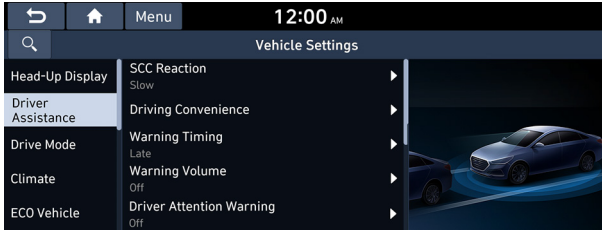

 The screen may differ depending on the vehicle model and specifications. Refer to the car owner's manual for details of the function.

Warning

- Be sure to always check the road conditions while driving. The Driver Assistance system helps you drive safely and conveniently. Relying solely on the function may cause violation of traffic rules and regulations, resulting in an accident.
- Be sure to control the vehicle by your judgment and keep traffic regulations for safety. When the function is active, drive the vehicle with keeping eyes forward and checking the surroundings.
- Not all warnings or functions are necessary when they are active, and they do not replace the driver discretion under any circumstances. Stay focused on the road while driving.

Caution

Be sure to always check the vehicle surroundings while driving. The equipped cameras and sensors may not operate properly under all driving conditions.

SCC Reaction (if equipped)

Adjusts the responsiveness of Smart Cruise Control to the acceleration of a leading vehicle.

Driving Convenience (if equipped)

Sets the properties of Driving Convenience system.

- ✎ The Driving Convenience system operates based on the information from the navigation system so you must use the system only when the navigation system operates properly.
- **Lane Following Assist:** Automatically adjusts the steering wheel to keep the vehicle centered in the lane.



Warning

Lane Following Assist is not a substitute for safe driving practices, but a convenience function. It is the responsibility of the driver to always be aware of the surroundings and steer the vehicle.



Caution

Be sure to always check the vehicle surroundings while driving, because Lane Following Assist may not work properly when the lane and road conditions are poor.

- **Highway Driving Assist:** Assists driving in a highway according to the set speed and distance to the leading vehicle while keeping the vehicle centered in the lane.
 - ✎ The highway driving assist system operates only on a highway. When the vehicle exits from the highway, the system is turned off automatically.
- **Highway Auto Speed Zone Slowdown:** Automatically decelerates in a highway speed enforcement zone.
 - ✎ The highway auto speed zone slowdown system operates only on a highway. When the vehicle exits from the highway, the system is turned off automatically.
 - ✎ It operates considering the speed cameras located on the selected route.
- **Highway Auto Curve Slowdown:** Automatically decelerates in a highway curve zone.
 - ✎ It operates based on the curve zones on the route. When the destination is not set, it operates based on the curve zones on the expected path.
- **Speed Limit Warning:** Displays the current speed limit of the road.

Warning Timing (if equipped)

Sets the timing of the warning.

Warning Volume (if equipped)

Sets the volume of the warning sound.

Driver Attention Warning (if equipped)

Sets the properties of the Driver Attention Warning system.

- **Leading Vehicle Departure Alert:** Alerts the driver during a stop, when the leading vehicle departs.



Warning

Be sure to always check the road conditions ahead or surroundings before departure. An accident caused by distracted driving can be prevented.

- **Safety Notice Call:** When abnormal driving is detected, a Connected Services Center representative will call to check on your safety.
- **Inattentive Driving Warning:** Provides a warning when signs of driver inattentiveness are detected, and recommends a rest if needed (if equipped).

Forward Safety (if equipped)

Sets the properties of the Forward Safety system.

- **Active Assist:** Provides a warning and vehicle control when a risk of forward collision is detected.



Warning

This function is only a supplemental function and it is not intended to, nor does it replace the need for extreme care and attention of the driver. The sensing range and objects detectable by the sensors are limited. Pay attention to the road conditions at all times.

- **Warning Only:** Provides a warning when a risk of forward collision is detected.
- **Off:** Disables the Forward Safety functions.

Lane Safety (if equipped)

Sets the properties of the Lane Safety system.

- **Assist:** Automatically assists with steering to help prevent the vehicle from leaving the lane.



Warning

Lane Keeping Assist is a supplementary function for safe driving and does not replace driving. It is the responsibility of the driver to always be aware of the surroundings and steer the vehicle.

 When the lanes are not recognized well by front view camera, always check the surroundings because Lane Keeping Assist may not work properly.

- **Warning Only:** Provides a warning when the vehicle leaves the lane without operating the turn signal switch.
- **Off:** Disables the Lane Safety functions.

Blind-Spot Safety (if equipped)

Sets the properties of the Blind-Spot Safety system.

- **Blind-Spot View:** Displays the blind-spot view in the cluster when operating the turn signal switch.
- **Safe Exit Assist:** Provides a warning and door control when an approaching vehicle is detected in the vehicle's blind spot.



Warning

- Safe Exit Assist may not operate properly when a vehicle is coming rapidly two lanes over from your vehicle or a vehicle is approaching at a fast speed from the rear in the lane next to your vehicle.
- Safe Exit Assist may not operate properly if there is any vehicle or obstacle at the rear area of your vehicle.
- Safe Exit Assist may be activated later than normal or may not operate properly if a vehicle is approaching fast from the rear of your vehicle.
- Safe Exit Assist may not operate when the Blind-Spot Safety system malfunctions as follows:
 - The warning message of the Blind-Spot Safety system appears on the instrument cluster.
 - The sensors of the Blind-Spot Safety system are contaminated or covered.
 - The Blind-Spot Safety system does not generate warning or generates a wrong alert.
- **Active Assist:** Provides a warning and vehicle control when a risk of blind-spot collision is detected.



Warning

Always be aware of road conditions while driving and be alert for unexpected situations even though Blind-Spot Collision Warning and Blind-Spot Collision-Avoidance Assist are operating.

- **Warning Only:** Provides a warning when a risk of blind-spot collision is detected.
- **Off:** Disables Blind-Spot Safety function.

Parking Safety (if equipped)

Sets the properties of the Parking Safety systems.

- **Surround View Monitor Auto On:** Automatically activates Surround View Monitor when Parking Distance Warning is active (if equipped).
- **Parking Distance Warning Auto On:** Automatically activates Parking Distance Warning when traveling at low speeds.

- **Rear Cross-Traffic Safety:** Provides a warning when a risk of rear cross-traffic collision is detected while reversing. It provides vehicle control to avoid collision, depending on the vehicle model and specifications.
- **Rear Active Assist:** Provides a warning and emergency braking when a risk of rear collision is detected while reversing.
- **Rear Warning Only:** Provides a warning when a risk of rear collision is detected while backing up.
- **Off:** Disables Parking Safety functions.

 **Warning**

- Even though the vehicle is equipped the Parking Safety system, be sure to check any obstacles in the surroundings while driving. Relying on the Parking Safety system may cause an accident. Accordingly, be sure to control the vehicle by your judgment.
- When the sensors cannot detect any obstacles due to the detection limit, it may cause an accident. Be sure to always check the surroundings while parking.

Drive Mode (if equipped)

You can change the vehicle settings for driving conditions.

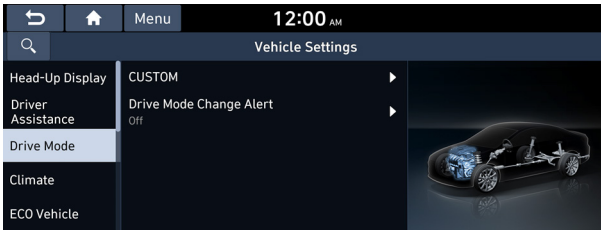

Option A

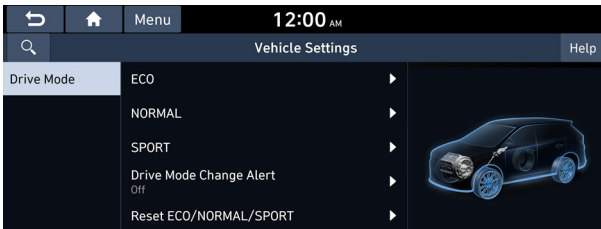

Option B (EV only)

 The screen may differ depending on the vehicle model and specifications.

CUSTOM (if equipped)

You can set to select the drive mode optimized for the driving habits or road conditions.

- **Powertrain:** Select a drive mode that performs optimum engine and transmission control depending on the driving situation.
 - **SMART:** Adjusts automatically based on driving activity: ECO/COMFORT/SPORT.
 - **ECO:** Optimized for fuel-efficient driving.
 - **NORMAL:** Optimized for balanced comfort.
 - **SPORT:** Optimized for agile driving.
 - **SPORT+:** Optimized for dynamic driving.
 - **SNOW:** Optimized for icy road conditions.
- **Steering:** Select a drive mode that performs optimum steering wheel control depending on the driving situation.
 - **NORMAL:** Optimized for smooth steering.
 - **SPORT:** Optimized for agile steering.
- **Suspension:** Select a drive mode that performs optimum suspension control to improve ride comfort depending on the driving situation.
 - **SMART:** Adjusts automatically based on driving activity: COMFORT+/COMFORT/SPORT.
 - **NORMAL:** Optimized for balanced comfort.
 - **SPORT:** Optimized for dynamic driving.
- **AWD:** Selects a four-wheel drive mode.
 - **SMART:** Optimized automatically based on driving habits.
 - **ECO:** Optimized for fuel-efficient driving.
 - **NORMAL:** Supports balanced comfort.
 - **SPORT:** Optimized for dynamic driving.
- **ESC:** This mode prevents the wheels from spinning and losing traction on slippery roads, so as to ensure vehicle stability for stable control.
 - **NORMAL:** Improves handling of the car in adverse conditions.
 - **SPORT:** Disables the stability control.

ECO (EV only)

This is a drive mode for increasing the vehicle's fuel efficiency. You can change the climate control mode, the active coast energy regeneration level, and speed limit settings.

NORMAL (EV only)

This is a drive mode focused on the driver and passenger's comfort. You can change the climate control mode and the active coast energy regeneration level.

SPORT (EV only)

This drive mode enables a more dynamic driving performance. You can change the climate control mode and the active coast energy regeneration level.

Drive Mode Change Alert (if equipped)

You can set how to display the notification message when the drive mode is changed.

- **Detailed Alert:** Displays a detailed notification message along with the vehicle image when the drive mode is changed.
- **Simple Alert:** Displays the notification at the top or on the split screen when the drive mode is changed.
- **Off:** When the drive mode changes, no notification is provided.

Reset ECO/NORMAL/SPORT (EV only)

You can reset the drive mode settings to the default values.

- ✍ The display may differ depending on the vehicle model and specifications.
- ✍ See how to improve ECO potential by pressing the **Help** button from an EV (Electric Vehicle). In most cases, a vehicle can travel a longer distance when its ECO potential score is higher (EV only).

Climate (if equipped)

You can configure the operation environment for climate control system.

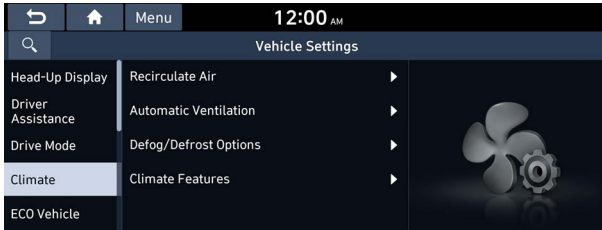

 The screen may differ depending on the vehicle model and specifications.

Recirculate Air (if equipped)

You can set to keep the inside air pleasant by blocking inflow of outside air.

- **Activate upon Washer Fluid Use:** Sets to automatically switch to the inside air circulation mode to prevent inflow of washer fluid scent when spraying washer fluid.
- **Activate Based on External Dust:** Sets to automatically switch to the air purification mode to keep inside air pleasant when the fine dust index is high.

Automatic Ventilation (if equipped)

You can set to prevent condensation inside and keep inside air pleasant using this feature.

- **Auto Dehumidify:** Once the inside air circulation mode has been used for a long time, it is switched to the outside air inflow mode to prevent condensation.
- **Smart Ventilation:** Sets to automatically switch to the outside air inflow mode to maintain a pleasant indoor environment when the humidity increases in the vehicle with the climate system off.
- **Carbon Dioxide Auto Vent:** Sets to automatically switch to the outside air inflow mode to maintain a pleasant indoor environment when the CO₂ concentration increases in the vehicle with the climate system off.

Defog/Defrost Options (if equipped)

You can set to enable the defogger to secure driver visibility.

- **Defog/Defrost:** When the sensor detects humidity on the windshield and glasses, it enables the outside air inflow mode and air conditioner for defogging and defrosting.
- **Auto Defog:** When the sensor detects fog on the windshield, the automatic ventilation is run for defogging.

Climate Features (if equipped)

You can set or change the settings for the climate system.

- **Rear Climate Controls:** Used to move to the climate control screen for the rear seat. You can check or set the climate status for the rear seat.

 For more information about controlling the rear-seat climate control system:
▶ see "Using the rear-seat climate control function (if equipped)."

ECO Vehicle (if equipped)

You can set the convenience features available for ECO vehicles.

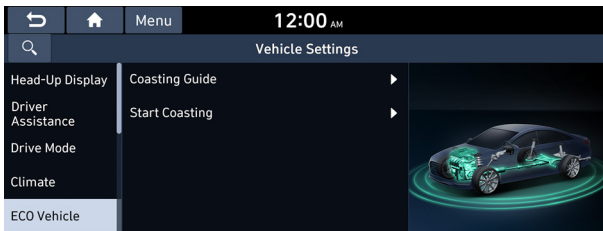

Coasting Guide (if equipped)

You can set the system to notify when to release the accelerator pedal to improve fuel efficiency.

Start Coasting (if equipped)

You can set when to receive the accelerator release notification.

Lights (if equipped)

You can configure the settings for vehicle lights.

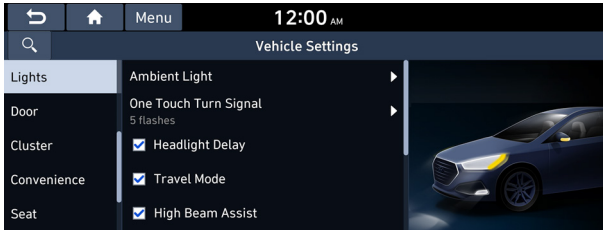

 The screen may differ depending on the vehicle model and specifications.

Ambient Light (if equipped)

You can set the brightness and color of the ambient light.

One Touch Turn Signal (if equipped)

You can set the number of turn signal lamp flashes when the lamp lever is operated.

Headlight Delay (if equipped)

You can set to turn off the taillights and headlights in 15 seconds after turning off the vehicle to ensure visibility.

Travel Mode (if equipped)

In countries whose driving direction is the opposite, you can set to decrease the headlamp lighting range for reducing glare of the driver in the opposite lane.

High Beam Assist (if equipped)

You can set to automatically control the high beam when an oncoming vehicle is approaching to decrease the high beam glare.

Intelligent High Beams (if equipped)

You can set the vehicle speed at which the intelligent headlamps operate.

Door (if equipped)

You can configure the operation environment for the trunk (liftgate) and doors.

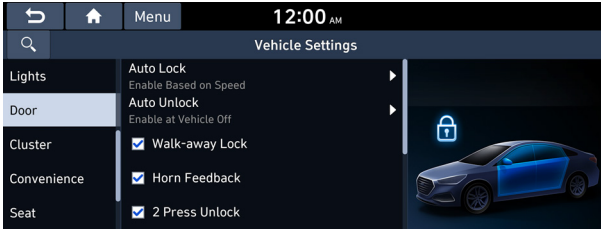

 The screen may differ depending on the vehicle model and specifications.

Auto Lock (if equipped)

You can set the time to automatically lock all doors.

Auto Unlock (if equipped)

You can set the time to automatically unlock all doors.

Walk-away Lock (if equipped)

You can set to automatically lock all doors when you move away from the vehicle with the smart key.

 When all doors are closed, this feature works normally.

Horn Feedback (if equipped)

You can set to generate guiding beep when all doors are locked.

2 Press Unlock (if equipped)

You can set to unlock all doors by pressing the door unlock button twice.

 When you press the door unlock button once, only the driver's seat door is unlocked.

Power Trunk or Power Liftgate (if equipped)

The Power trunk (liftgate) button can be used to automatically open/close the trunk (liftgate).

 The displayed name may differ depending on the vehicle model and specifications.

Power Trunk Opening Speed or Power Liftgate Opening Speed (if equipped)

Selects the speed the power trunk (liftgate) automatically moves.

✍ The displayed name may differ depending on the vehicle model and specifications.

Power Trunk Opening Height or Power Liftgate Opening Height (if equipped)

Set the opening height for the power trunk (liftgate).

✍ The displayed name may differ depending on the vehicle model and specifications.

Smart Trunk or Smart Liftgate (if equipped)

Opens the trunk (liftgate) automatically when approaching the trunk (liftgate) with the smart key.

✍ The displayed name may differ depending on the vehicle model and specifications.

Cluster (if equipped)

You can set the data to display on the instrument cluster and the volume and type for guiding beep.



✍ The screen may differ depending on the vehicle model and specifications.

Service Interval (if equipped)

You can set to guide you when to perform the vehicle inspection.

- **Enable Service Interval:** Sets the service inspection interval. When it exceeds, the notification is provided.
- **Distance:** Sets the driving distance for a service.
- **Duration:** Sets the service cycle.
- **Reset:** Initializes the settings for distance and duration.

Energy Consumption Reset (if equipped)

You can set to automatically initialize the average fuel economy.

- **After Ignition:** The average fuel economy is automatically initialize whenever you drive the vehicle.
- **After Refueling:** The average fuel economy is automatically initialize whenever you refuel the vehicle.
- **Off:** The average fuel economy initialize is unavailable.

Reset Fuel Economy (if equipped)

You can select which average fuel economy to display on the cluster.

- **At Vehicle Start:** Displays the fuel economy after engine restart.
- **After Refueling:** Displays the fuel economy after refueling.
- **Manually:** Displays the accumulated fuel economy.

Content Selection (if equipped)

You can set the content to display on the instrument cluster.

- **Gear Position Pop-up:** When the gear is shifted, the information pop-up appears.
- **Wiper/Lights Display:** When the wiper or light lever operates, the operation mode appears.
- **Traffic Signs:** Displays the road information such as speed bumps and speed limits.
- **Icy Road Warning:** When the outside temperature drops below 4 °C (39 °F), the possibility of road icing appears.

Cluster Voice Guidance Volume (if equipped)

You can adjust the volume of guiding beep.

Welcome Sound (if equipped)

You can set to generate the notification sound when turning on or off the instrument cluster.

Speedometer Subscale (if equipped)

You can set to display the speedometer subscale on the instrument cluster.

Convenience (if equipped)

You can configure the features for convenience such as welcome sound and wireless charging.



 The screen may differ depending on the vehicle model and specifications.

Rear Occupant Alert (if equipped)

Movement is detected by the rear-seat sensor after the doors are locked.

Welcome Mirror/Light (if equipped)

You can set the welcoming time on the outside rear view mirrors.

- **Enable on Door Unlock:** The welcome feature is enabled by the door unlock event.
- **Enable on Driver Approach:** When the driver with the smart key approaches, the welcome feature is enabled.

Wireless Charging System (if equipped)

You can set to charge your smartphone wirelessly.

 This feature is available only in smartphones that can be charged wirelessly.

Active Sound Design (if equipped)

You can turn on or off the engine sound feature that generates engine sound.

Auto Rear Wiper (in R) (if equipped)

Activates the rear windshield wiper automatically when the front wiper is On and the gear is in reverse.

Vehicle Auto-Shut Off (if equipped)

You can set to turn off the engine automatically when the vehicle is left idle in park mode for a set period.

Seat (if equipped)

You can set to use various features (motions and warmer control for the driver's seat, rear seat, and steering wheel) that are related to the seats and steering wheel.

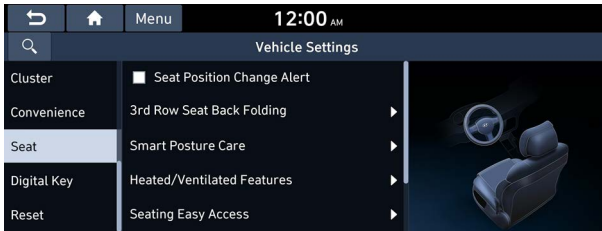

 The screen may differ depending on the vehicle model and specifications.

Seat Position Change Alert (if equipped)

You can set the system to display a notification message along with the seat image on the screen when a seat position is changed.

3rd Row Seat Back Folding (if equipped)

You can fold or unfold the left or right seat back of the 3rd row seat.

- **Fold:** Can fold the 3rd row rear seat backs.
- **Unfold:** Can unfold the 3rd row rear seat backs.

Smart Posture Care (if equipped)

You can see the recommended driving posture according to your physical data, and the clinical inspection result for your waist.

Heated/Ventilated Features (if equipped)

You can set to make the driving environment pleasant by controlling the steering wheel warmer and driver's seat warmer/ventilation.

- **Auto. Controls That Use Climate Control Settings:** Automatically controls the heating wire or ventilation for the driver's seat and steering wheel, in sync with the climate control function.
 - **Steering Wheel Warmer:** Steering Wheel Warmer adjusts automatically based on Climate settings.
 - **Seat Warmer/Ventilation:** Seat Warmer/Ventilation adjusts automatically based on Climate settings.

Seating Easy Access (if equipped)

For convenience upon getting on and off, you can adjust the position of the driver's seat or steering wheel to secure space inside the vehicle.

- **Steering Easy Access:** The steering wheel moves upward when getting on and off.
- **Seat Slide Easy Access:** Can set the distance to automatically move the driver's seat when getting on or off.
- **Seat Height Easy Access:** Can set to automatically move the driver's seat when getting on or off.

Rear Seat Heating Control (if equipped)

You can set to enable the warmer for the rear-left and rear-right seats.

Digital Key (if equipped)

You can register or delete a digital key and then see the information of the registered digital key.

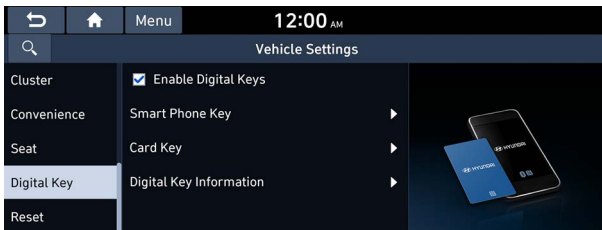

Enable Digital Keys (if equipped)

You can set whether or not to use the digital keys.

Smart Phone Key (if equipped)

You can register or delete a smartphone key.

Card Key (if equipped)

You can register or delete a card key.

Digital Key Information (if equipped)

You can see the serial number of the registered digital key.

Reset (if equipped)

You can initialize all system settings in the vehicle.

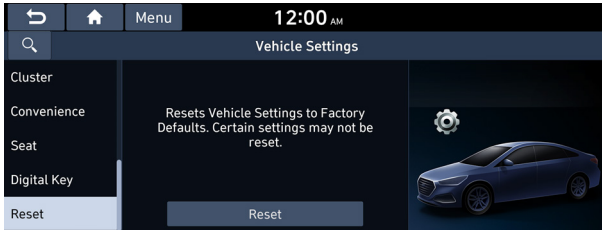

✎ The required features cannot be initialize.

✎ The screen may differ depending on the vehicle model and specifications.

Configuring the vehicle settings (Type2)

(if equipped)

You can configure the functions for driving and related environments.

Warning

Make sure you stop the vehicle before changing settings to ensure safety.

✎ Vehicle settings can be changed only when the vehicle is on.

✎ Available settings may differ depending on the vehicle model and specifications.

✎ Depending on the climate control system, some functions may not be supported.

1 On the All Menus screen, press **Setup ► Vehicle**.

The vehicle settings screen appears.

2 Configure the settings required:

✎ Press  ► **Search for Settings** or press  and enter a keyword to search for a setting item. You can also search for a setting item by voice.

Driver Assistance (if equipped)

You can set to use various systems that assist the driver for safety.



 The screen may differ depending on the vehicle model and specifications. Refer to the car owner's manual for details of the function.

Warning

- Be sure to always check the road conditions while driving. The Driver Assistance system helps you drive safely and conveniently. Relying solely on the function may cause violation of traffic rules and regulations, resulting in an accident.
- Be sure to control the vehicle by your judgment and keep traffic regulations for safety. When the function is active, drive the vehicle with keeping eyes forward and checking the surroundings.
- Not all warnings or functions are necessary when they are active, and they do not replace the driver discretion under any circumstances. Stay focused on the road while driving.

Caution

Be sure to always check the vehicle surroundings while driving. The equipped cameras and sensors may not operate properly under all driving conditions.

SCC Reaction (if equipped)

Adjusts the responsiveness of Smart Cruise Control to the acceleration of a leading vehicle.

Driving Convenience (if equipped)

Sets the properties of Driving Convenience system.

 The Driving Convenience system operates based on the information from the navigation system so you must use the system only when the navigation system operates properly.

- **Lane Following Assist:** Automatically adjusts the steering wheel to keep the vehicle centered in the lane.



Warning

Lane Following Assist is not a substitute for safe driving practices, but a convenience function. It is the responsibility of the driver to always be aware of the surroundings and steer the vehicle.



Caution

Be sure to always check the vehicle surroundings while driving, because Lane Following Assist may not work properly when the lane and road conditions are poor.

- **Highway Driving Assist:** Assists driving in a highway according to the set speed and distance to the leading vehicle while keeping the vehicle centered in the lane.
 - ✍ The highway driving assist system operates only on a highway. When the vehicle exits from the highway, the system is turned off automatically.
- **Highway Lane Change Assist:** Automatically adjusts the vehicle speed on a highway based on navigation data.
- **Highway Auto Speed Zone Slowdown:** Automatically decelerates in a highway speed enforcement zone.
 - ✍ The highway auto speed zone slowdown system operates only on a highway. When the vehicle exits from the highway, the system is turned off automatically.
 - ✍ It operates considering the speed cameras located on the selected route.
- **Highway Auto Curve Slowdown:** Automatically decelerates in a highway curve zone.
 - ✍ It operates based on the curve zones on the route. When the destination is not set, it operates based on the curve zones on the expected path.
- **Highway Auto Speed Change:** Automatically adjusts the vehicle speed on a highway based on navigation data.
- **Speed Limit Warning:** Displays the current speed limit of the road.

Speed Limit (if equipped)

Sets the properties of the Speed Limit system.

- **Speed Limit Offset:** Adjusts the offset amount of the speed limit.
- **Speed Limit Assist:** Adjusts the vehicle set speed based on the current speed limit of the road.
- **Speed Limit Warning:** Provides a warning when the speed limit is exceeded.
- **Off:** Disables the Speed Limit functions.

Warning Timing (if equipped)

Sets the timing of the warning.

Warning Volume (if equipped)

Sets the volume of the warning sound.

Haptic Warning (if equipped)

Sets the intensity of the steering wheel vibration warning.

Driver Attention Warning (if equipped)

Sets the properties of the Driver Attention Warning system.

- **Leading Vehicle Departure Alert:** Alerts the driver during a stop, when the leading vehicle departs.



Warning

Be sure to always check the road conditions ahead or surroundings before departure. An accident caused by distracted driving can be prevented.

- **Inattentive Driving Warning:** Provides a warning when signs of driver inattentiveness are detected, and recommends a rest if needed.
- **Safety Notice Call:** When abnormal driving is detected, a Connected Services Center representative will call to check on your safety.

Forward Safety (if equipped)

Sets the properties of the Forward Safety system.

- **Auto OFF in N mode:** Automatically disables Driving Safety systems when N mode is selected.
- **Forward Cross-Traffic Safety:** Provides a warning and emergency braking when a risk of forward cross-traffic collision is detected.
- **Active Assist:** Provides a warning and vehicle control when a risk of forward collision is detected.



Warning

This function is only a supplemental function and it is not intended to, nor does it replace the need for extreme care and attention of the driver. The sensing range and objects detectable by the sensors are limited. Pay attention to the road conditions at all times.

- **Warning Only:** Provides a warning when a risk of forward collision is detected.
- **Off:** Disables the Forward Safety functions.

Lane Safety (if equipped)

Sets the properties of the Lane Safety system.

- **Assist:** Automatically assists with steering to help prevent the vehicle from leaving the lane.



Warning

Lane Keeping Assist is a supplementary function for safe driving and does not replace driving. It is the responsibility of the driver to always be aware of the surroundings and steer the vehicle.

 When the lanes are not recognized well by front view camera, always check the surroundings because Lane Keeping Assist may not work properly.

- **Warning Only:** Provides a warning when the vehicle leaves the lane without operating the turn signal switch.
- **Off:** Disables the Lane Safety functions.

Blind-Spot Safety (if equipped)

Sets the properties of the Blind-Spot Safety system.

- **Blind-Spot View:** Displays the blind-spot view in the cluster when operating the turn signal switch.
- **Safe Exit Assist:** Provides a warning and door control when an approaching vehicle is detected in the vehicle's blind spot.
- **Safe Exit Warning:** Provides a warning when an approaching vehicle is detected in the vehicle's blind spot.



Warning

- Safe Exit Assist may not operate properly when a vehicle is coming rapidly two lanes over from your vehicle or a vehicle is approaching at a fast speed from the rear in the lane next to your vehicle.
- Safe Exit Assist may not operate properly if there is any vehicle or obstacle at the rear area of your vehicle.
- Safe Exit Assist may be activated later than normal or may not operate properly if a vehicle is approaching fast from the rear of your vehicle.
- Safe Exit Assist may not operate when the Blind-Spot Safety system malfunctions as follows:
 - The warning message of the Blind-Spot Safety system appears on the instrument cluster.
 - The sensors of the Blind-Spot Safety system are contaminated or covered.
 - The Blind-Spot Safety system does not generate warning or generates a wrong alert.

- **Active Assist:** Provides a warning and vehicle control when a risk of blind-spot collision is detected.



Warning

Always be aware of road conditions while driving and be alert for unexpected situations even though Blind-Spot Collision Warning and Blind-Spot Collision-Avoidance Assist are operating.

- **Warning Only:** Provides a warning when a risk of blind-spot collision is detected.
- **Off:** Disables Blind-Spot Safety function.

Parking Safety (if equipped)

Sets the properties of the Parking Safety systems.

- **Camera Settings:** Sets the properties of the cameras.
 - **Display Contents:** Specify information that will be displayed on the view screen. Setting items may differ depending on the vehicle model and camera type.
 - **Display Settings:** Adjust the brightness and contrast of the view screen. To initialize all Surround View or Rear View screen settings of the phone projection, press **Reset**.
- **Surround View Monitor Auto On:** Automatically activates Surround View Monitor when Parking Distance Warning is active.
- **Parking Distance Warning Auto On:** Automatically activates Parking Distance Warning when traveling at low speeds.
- **Rear Safety:** Provides a warning and emergency braking when a risk of rear collision is detected while reversing.
- **Rear Active Assist:** Provides a warning and emergency braking when a risk of rear collision is detected while reversing.
- **Rear Warning Only:** Provides a warning when a risk of rear collision is detected while backing up.
- **Off:** Disables Parking Safety functions.
- **Rear Cross-Traffic Safety:** Provides a warning when a risk of rear cross-traffic collision is detected while reversing. It provides vehicle control to avoid collision, depending on the vehicle model and specifications.



Warning

- Even though the vehicle is equipped the Parking Safety system, be sure to check any obstacles in the surroundings while driving. Relying on the Parking Safety system may cause an accident. Accordingly, be sure to control the vehicle by your judgment.
- When the sensors cannot detect any obstacles due to the detection limit, it may cause an accident. Be sure to always check the surroundings while parking.

Drive Mode (if equipped)

You can change the vehicle settings for driving conditions.

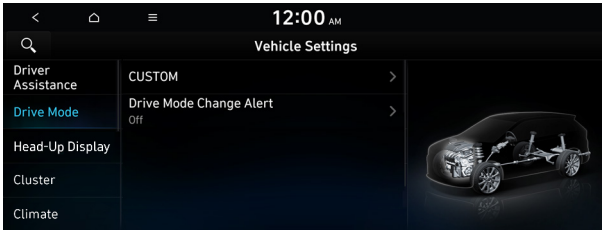

Option A

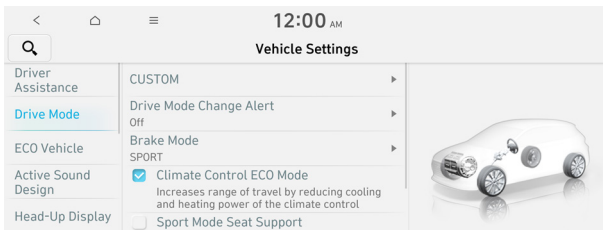

Option B (EV only)

 The screen may differ depending on the vehicle model and specifications.

CUSTOM (if equipped)

You can set to select the drive mode optimized for the driving habits or road conditions.

- **Powertrain:** Select a drive mode that performs optimum engine and transmission control depending on the driving situation.
 - **SMART:** Adjusts automatically based on driving activity: ECO/COMFORT/SPORT.
 - **ECO:** Optimized for fuel-efficient driving.
 - **NORMAL:** Optimized for balanced comfort.
 - **SPORT:** Optimized for agile driving.
 - **SNOW:** Optimized for icy road conditions.
- **Steering:** Select a drive mode that performs optimum steering wheel control depending on the driving situation.
 - **NORMAL:** Optimized for smooth steering.
 - **SPORT:** Optimized for agile steering.

- **Suspension:** Select a drive mode that performs optimum suspension control to improve ride comfort depending on the driving situation.
 - **SMART:** Adjusts automatically based on driving activity: COMFORT+/COMFORT/SPORT.
 - **NORMAL:** Optimized for balanced comfort.
 - **SPORT:** Optimized for dynamic driving.
- **AWD:** Selects a four-wheel drive mode.
 - **SMART:** Optimized automatically based on driving habits.
 - **ECO:** Optimized for fuel-efficient driving.
 - **NORMAL:** Supports balanced comfort.
 - **SPORT:** Optimized for dynamic driving.

ECO (EV only)

This is a drive mode for increasing the vehicle's fuel efficiency. You can change the climate control mode, the active coast energy regeneration level, and speed limit settings.

NORMAL (EV only)

This is a drive mode focused on the driver and passenger's comfort. You can change the climate control mode and the active coast energy regeneration level.

SPORT (EV only)

This drive mode enables a more dynamic driving performance. You can change the climate control mode and the active coast energy regeneration level.

Drive Mode Change Alert (if equipped)

You can set how to display the notification message when the drive mode is changed.

- **Detailed Alert:** Displays a detailed notification message along with the vehicle image when the drive mode is changed.
- **Simple Alert:** Displays the notification at the top or on the split screen when the drive mode is changed.
- **Off:** When the drive mode changes, no notification is provided.

Brake Mode (if equipped)

You can set brake pedal feel depending on your driving habits.

Climate Control ECO Mode (if equipped)

Decrease the cooling/heating level to increase the drivable range.

Reset ECO/NORMAL/SPORT (if equipped)

You can reset the drive mode settings to the default values.

- ✍ The display may differ depending on the vehicle model and specifications.
- ✍ See how to improve ECO potential by pressing the **Help** button from an EV (Electric Vehicle). In most cases, a vehicle can travel a longer distance when its ECO potential score is higher (EV only).

ECO Vehicle (if equipped)

You can set the convenience features available for ECO vehicles.



Option A

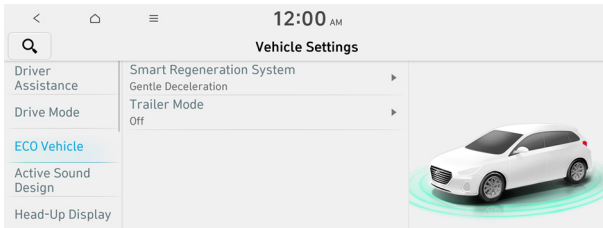

Option B (EV only)

- ✍ The screen may differ depending on the vehicle model and specifications.

Coasting Guide (if equipped)

You can set the system to notify when to release the accelerator pedal to improve fuel efficiency.

Start Coasting (if equipped)

You can set when to receive the accelerator release notification.

Smart Regeneration (if equipped)

Set to activate regenerative braking automatically based on the vehicle state or driving conditions.

Smart Regeneration System (if equipped)

Adjusts the deceleration strength during Smart Regeneration System.

Charging Connector Locking Mode (if equipped)

Configure the lock mode setting for the connected charging cable.

Charging Voice Prompts (if equipped)

Configure the settings so that voice information about charging status is provided as soon as charging begins.

Green Zone Drive Mode (if equipped)

When you are driving in an area that needs to improve air quality, set to drive in EV mode as much as possible.

Trailer Mode (if equipped)

Maintain driving performance and estimate the drivable range when a trailer is connected.

Head-Up Display (if equipped)

You can set to use the head-up display that displays information such as driving speed and road-related information while driving.



 The screen may differ depending on the vehicle model and specifications.

Enable Head-Up Display (if equipped)

Can determine whether or not to use the head-up display.

Display Control (if equipped)

Adjust the height, rotation, and brightness of the head-up display.

Content Selection (if equipped)

Select the items to display on the head-up display.

Speedometer (if equipped)

Can set the driving speed items and colors to display on the head-up display.

Head-Up Display (for IONIQ 5 only) (if equipped)

You can turn on the augmented reality (AR) head-up display function which displays information such as driving speed and road-related information while driving.

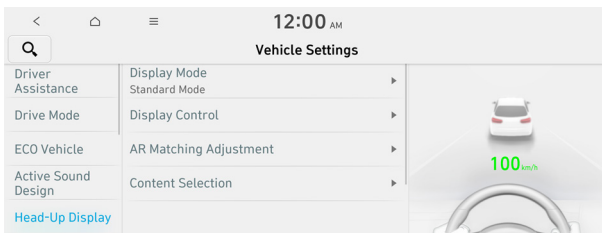

Display Mode (if equipped)

Enable/disable the head-up display, and configure the display mode settings.

Display Control (if equipped)

Adjust the height, rotation, and brightness of the head-up display.

AR Matching Adjustment (if equipped)

Adjust settings so that vehicle position on road matches information shown on the head-up display.

Content Selection (if equipped)

Select the items to display on the head-up display.

Cluster (if equipped)

You can set the data to display on the instrument cluster and the volume and type for guiding beep.



 The screen may differ depending on the vehicle model and specifications.

Illumination (if equipped)

You can set the instrument cluster display brightness.

Cluster Theme Selection (if equipped)

Select and apply a theme to the cluster.

Service Interval (if equipped)

You can set to guide you when to perform the vehicle inspection.

- **Enable Service Interval:** Sets the service inspection interval. When it exceeds, the notification is provided.
- **Distance:** Sets the driving distance for a service.
- **Duration:** Sets the service cycle.
- **Reset:** Initializes the settings for distance and duration.

Energy Consumption Reset (if equipped)

You can set to automatically initialize the average fuel economy.

- **After Ignition:** The average fuel economy is automatically initialize whenever you drive the vehicle.
- **After Refueling:** The average fuel economy is automatically initialize whenever you refuel the vehicle.
- **After Recharging:** The average fuel economy is automatically initialize whenever you charge the vehicle (EV only).
- **Off:** The average fuel economy initialize is unavailable.

Reset Fuel Economy (if equipped)

Select which average fuel economy to display on the cluster.

- **At Vehicle Start:** Displays the fuel economy after engine
- **After Refueling:** Displays the fuel economy after refueling.
- **After Recharging:** Displays the fuel economy after recharging (EV only).
- **Manually:** Displays the accumulated fuel economy.

Content Selection (if equipped)

You can set the content to display on the instrument cluster.

- **Gear Position Pop-up:** When the gear is shifted, the information pop-up appears.
- **Wiper/Lights Display:** When the wiper or light lever operates, the operation mode appears.
- **Traffic Signs:** Displays the road information such as speed bumps and speed limits.
- **Blind-Spot View:** Displays the blind spot view on the instrument cluster when the turn signal lamp is blinking.
- **Icy Road Warning:** When the outside temperature drops below 4 °C (39 °F), the possibility of road icing appears.

Cluster Voice Guidance Volume (if equipped)

You can adjust the voice guidance volume of the cluster.

Welcome Sound (if equipped)

You can set to generate the notification sound when turning on or off the instrument cluster.

Speedometer Subscale (if equipped)

You can set to display the speedometer subscale on the instrument cluster.

Climate (if equipped)

You can configure the operation environment for climate control system.



 The screen may differ depending on the vehicle model and specifications.

Recirculate Air (if equipped)

You can set to keep the inside air pleasant by blocking inflow of outside air.

- **Activate upon Washer Fluid Use:** Sets to automatically switch to the inside air circulation mode to prevent inflow of washer fluid scent when spraying washer fluid.
- **Activate Based on External Dust:** Sets to automatically switch to the air purification mode to keep inside air pleasant when the fine dust index is high.
- **Recirculation Mode Plus:** Sets automatically control windows or climate system to keep inside air pleasant with synced with the navigation system.

Automatic Ventilation (if equipped)

You can set to prevent condensation inside and keep inside air pleasant using this feature.

- **Automatic Dehumidify:** Once the inside air circulation mode has been used for a long time, it is switched to the outside air inflow mode to prevent condensation.
- **Smart Ventilation:** Sets to automatically switch to the outside air inflow mode to maintain a pleasant indoor environment when the humidity increases in the vehicle with the climate system off.
- **Carbon Dioxide Auto Vent:** Sets to automatically switch to the outside air inflow mode to maintain a pleasant indoor environment when the CO₂ concentration increases in the vehicle with the climate system off.
- **Scheduled Ventilation:** Automatically ventilates the cabin at the scheduled time. Ventilation occurs while the vehicle is off.

Defog/Defrost Options (if equipped)

You can set to enable the defogger to secure driver visibility.

- **Defog/Defrost:** When the sensor detects humidity on the windshield and glasses, it enables the outside air inflow mode and air conditioner for defogging and defrosting.
- **Auto Defog:** When the sensor detects fog on the windshield, the automatic ventilation is run for defogging.

Climate Features (if equipped)

You can set or change the settings for the climate system.

- **A/C Automatic Drying:** You can set the climate control system to dry the air conditioner by running when the engine is stopped.
- **Rear Climate Controls:** Used to move to the climate control screen for the rear seat. You can check or set the climate status for the rear seat (if equipped).

 For more information about controlling the rear-seat climate control system:
▶ see "Using the rear-seat climate control function (if equipped)."

Warmer/Ventilation Features (if equipped)

You can set to make the driving environment pleasant by controlling the steering wheel warmer and driver's seat warmer/ventilation.

- **Link to Climate Settings for Auto-Adjustment:** Automatically controls the heating wire or ventilation for the driver's seat and steering wheel, in sync with the climate control function.
 - **Steering Wheel Warmer:** Steering Wheel Warmer adjusts automatically based on Climate settings.
 - **Driver Seat Warmer/Ventilation:** Seat Warmer/Ventilation adjusts automatically based on Climate settings.

Seat (if equipped)

You can set to use various features (motions and warmer control for the driver's seat, rear seat, and steering wheel) that are related to the seats and steering wheel.

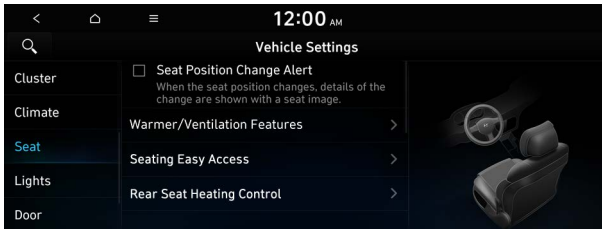

 The screen may differ depending on the vehicle model and specifications.

Seat Position Change Alert (if equipped)

You can set the system to display a notification message along with the seat image on the screen when a seat position is changed.

3rd Row Seat Back Folding (if equipped)

You can fold or unfold the left or right seat back of the 3rd row seat.

- **Fold:** Can fold the 3rd row rear seat backs.
- **Unfold:** Can unfold the 3rd row rear seat backs.

Smart Posture Care (if equipped)

You can see the recommended driving posture according to your physical data, and the clinical inspection result for your waist.

Warmer/Ventilation Features (if equipped)

You can set to make the driving environment pleasant by controlling the steering wheel warmer and driver's seat warmer/ventilation.

- **Link to Climate Settings for Auto-Adjustment:** Automatically controls the heating wire or ventilation for the driver's seat and steering wheel, in sync with the climate control function.
 - **Steering Wheel Warmer:** Steering Wheel Warmer adjusts automatically based on Climate settings.
 - **Driver Seat Warmer/Ventilation:** Seat Warmer/Ventilation adjusts automatically based on Climate settings.

Seating Easy Access (if equipped)

For convenience upon getting on and off, you can adjust the position of the driver's seat or steering wheel to secure space inside the vehicle.

- **Seat Slide Easy Access:** Can set the distance to automatically move the driver's seat when getting on or off.
- **Seat Height Easy Access:** Can set to automatically move the driver's seat when getting on or off.
- **Steering Easy Access:** The steering wheel moves upward when getting on and off.

Rear Seat Heating Control (if equipped)

You can set to enable the warmer for the rear-left and rear-right seats.

Lights (if equipped)

You can configure the settings for vehicle lights.

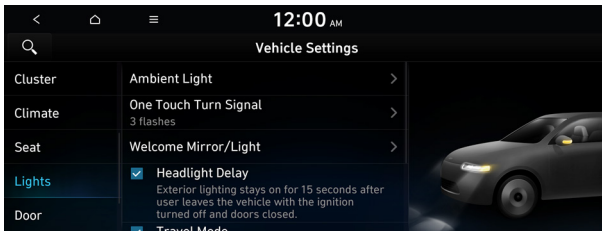

 The screen may differ depending on the vehicle model and specifications.

Ambient Light (if equipped)

You can set the brightness and color of the ambient light.

 To turn off the interior mood lamp, adjust the brightness to 0.

- **Dimmed while Driving:** This mode automatically decreases the interior mood lamp brightness when the gear is shifted to a position other than "P" (park) at night.

One Touch Turn Signal (if equipped)

You can set the number of turn signal lamp flashes when the lamp lever is operated.

Welcome Mirror/Light (if equipped)

You can set the welcoming time on the outside rear view mirrors.

- **Enable on Door Unlock:** The welcome feature is enabled by the door unlock event.
- **Enable on Driver Approach:** When the driver with the smart key approaches, the welcome feature is enabled.

Headlight Delay (if equipped)

You can set to turn off the taillights and headlights in 15 seconds after turning off the vehicle to ensure visibility.

Travel Mode (if equipped)

In countries whose driving direction is the opposite, you can set to decrease the headlamp lighting range for reducing glare of the driver in the opposite lane.

High Beam Assist (if equipped)

You can set to automatically control the high beam when an oncoming vehicle is approaching to decrease the high beam glare.

Intelligent High Beams (if equipped)

You can set the vehicle speed at which the intelligent headlamps operate.

Door (if equipped)

You can configure the operation environment for the trunk (liftgate) and doors.

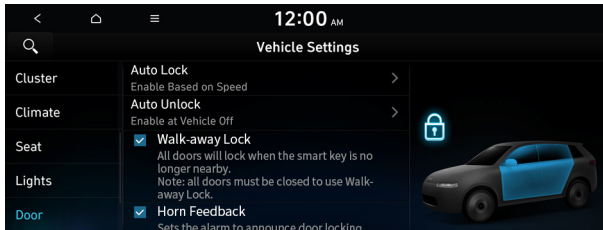

 The screen may differ depending on the vehicle model and specifications.

Auto Lock (if equipped)

You can set the time to automatically lock all doors.

Auto Unlock (if equipped)

You can set the time to automatically unlock all doors.

Walk-away Lock (if equipped)

You can set to automatically lock all doors when you move away from the vehicle with the smart key.

ℹ When all doors are closed, this feature works normally.

Horn Feedback (if equipped)

You can set to generate guiding beep when all doors are locked.

2 Press Unlock (if equipped)

You can set to unlock all doors by pressing the door unlock button twice.

ℹ When you press the door unlock button once, only the driver's seat door is unlocked.

Power Trunk or Power Liftgate (if equipped)

The Power trunk (liftgate) button can be used to automatically open/close the trunk (liftgate).

ℹ The displayed name may differ depending on the vehicle model and specifications.

Power Trunk Opening Speed or Power Liftgate Opening Speed (if equipped)

Selects the speed the power trunk (liftgate) automatically moves.

ℹ The displayed name may differ depending on the vehicle model and specifications.

Power Trunk Opening Height or Power Liftgate Opening Height (if equipped)

Set the opening height for the power trunk (liftgate).

ℹ The displayed name may differ depending on the vehicle model and specifications.

Smart Trunk or Smart Liftgate (if equipped)

Opens the trunk (liftgate) automatically when approaching the trunk (liftgate) with the smart key.

ℹ The displayed name may differ depending on the vehicle model and specifications.

Digital Key (if equipped)

You can register or delete a digital key and then see the information of the registered digital key.

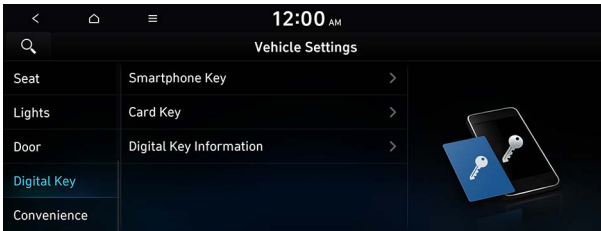

 The screen may differ depending on the vehicle model and specifications.

Enable Digital Keys (if equipped)

You can set whether or not to use the digital keys.

Smartphone Key (if equipped)

You can register or delete a smartphone key.

Card Key (if equipped)

You can register or delete a card key.

Digital Key Information (if equipped)

You can see the serial number of the registered digital key.

Convenience (if equipped)

You can configure the features for convenience such as welcome sound and wireless charging.

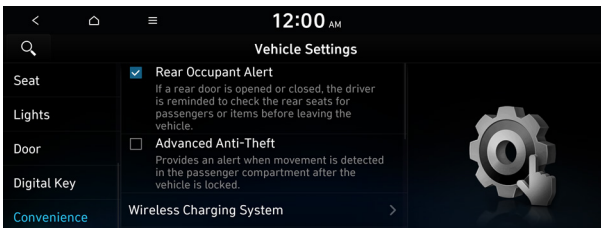

 The screen may differ depending on the vehicle model and specifications.

Rear Occupant Alert (if equipped)

Movement is detected by the rear-seat sensor after the doors are locked.

Advanced Anti-Theft (if equipped)

You can set to display an alert when any motion is detected inside the vehicle with the vehicle locked.

Wireless Charging System (if equipped)

You can set to charge your smartphone wirelessly.

 This feature is available only in smartphones that can be charged wirelessly.

Active Sound Design (if equipped)

You can turn on or off the engine sound feature that generates engine sound.

Auto Rear Wiper (in R) (if equipped)

Activates the rear windshield wiper automatically when the front wiper is On and the gear is in reverse.

Vehicle Auto-Shut Off (if equipped)

You can set to turn off the engine automatically when the vehicle is left idle in park mode for a set period.



Configuring the device connections settings (Type1)

You can manage Bluetooth devices or configure their operation settings. You can also activate the phone projection so that you can control the smartphone Apps on the system screen after connecting the smartphone to the system.

1 On the All Menus screen, press **Setup ► Device Connections.**

The device connection settings screen appears.

2 Configure the settings required:

 Press **Menu ► Search for Settings** or press  and enter a keyword to search for a setting item. You can also search for a setting item by voice.

Bluetooth

You can register or delete a Bluetooth device for the system and connect or disconnect a registered device. You can also configure operation settings such as notifications, messages, and other settings for Bluetooth devices.

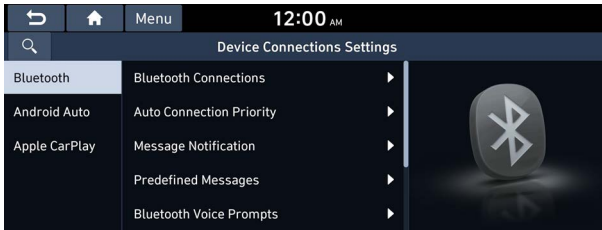

- ✍ For more information on how to use the Bluetooth functions: ► see "[Connecting a Bluetooth device.](#)"
- ✍ Some setting options appear when a smartphone is connected to the system.
- ✍ To edit or delete a message, park the vehicle at a safe place and access the messaging function on your smartphone. You cannot edit or delete a message from the system.
- ✍ When an iPhone is connected to the system, there are some restrictions when receiving messages as follows:
 - Only the sender name appears when the sender information is saved.
 - Only the phone number appears when the sender information is not saved.
 - You cannot use the auto-reply message function.
 - When the incoming message notification or lock-screen view option is off, messages cannot be received.
- ✍ The message reader function may not be supported depending on the system language.

Bluetooth Connections

You can register or delete a Bluetooth device from the system and connect or disconnect a registered device.

 You can add one Bluetooth hands-free kit or up to two Bluetooth audio devices.

Auto Connection Priority

Set the priority order for automatic Bluetooth connection to the system when it turns on.

 On the device list, press  on the right and drag the item to reposition.

Message Notification

Set to receive message notifications.

 This option may not be available in some phone models.

Predefined Messages

Edit message templates for quick replies.

 This option may not be available in some phone models.

Bluetooth Voice Prompts

Set whether to hear voice prompts for events related to Bluetooth connections.

Privacy Mode

Enable or disable Privacy Mode. Hide data including contacts and call history from showing up on the system screen to protect privacy.

Bluetooth System Info

You can see and edit the Bluetooth information of the system.

Reset

You can delete all registered Bluetooth devices and initialize Bluetooth settings. All data for Bluetooth devices are also deleted.

Android Auto

You can activate the Android Auto function to pair your Android smartphone with the system.

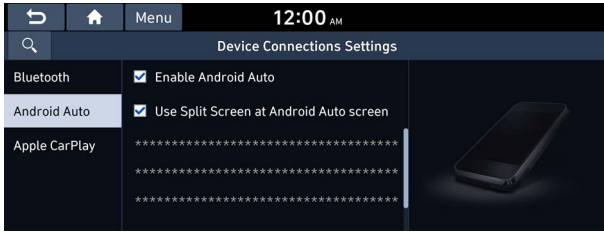

Apple CarPlay

You can activate the Apple CarPlay function to pair your iPhone with the system.

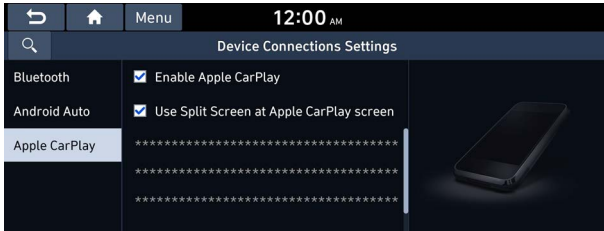

Configuring the device connections settings (Type2)

You can manage Bluetooth devices or configure their operation settings. You can also activate the phone projection so that you can control the smartphone Apps on the system screen after connecting the smartphone to the system.

- 1 On the All Menus screen, press **Setup ► Device Connections**.
The device connection settings screen appears.
- 2 Configure the settings required:
 - ✎ Press **☰ ► Search for Settings** or press **🔍** and enter a keyword to search for a setting item. You can also search for a setting item by voice.

Device Connections

You can register or delete a Bluetooth device from the system and connect or disconnect a registered device.

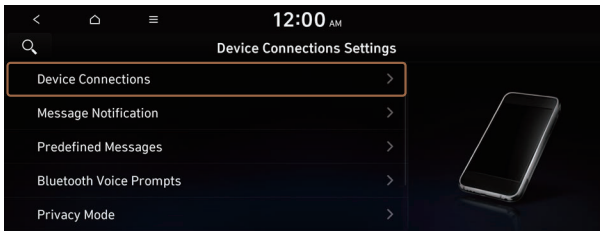

- ✎ You can add one Bluetooth hands-free kit or up to two Bluetooth audio devices.
- ✎ On the device list, press **☰** on the right and drag to reposition set the priority order.

Message Notification

Set to receive message notifications.

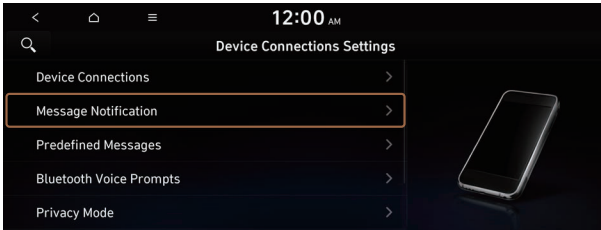

 This option may not be available in some phone models.

Predefined Messages

Edit message templates for quick replies.

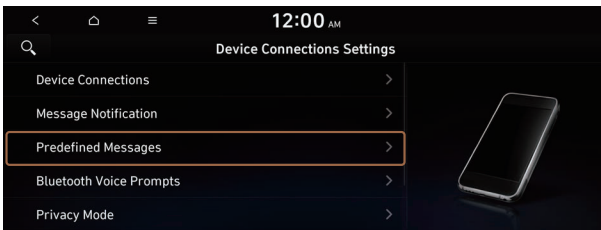

 This option may not be available in some phone models.

Bluetooth Voice Prompts

Set whether to hear voice prompts for events related to Bluetooth connections.

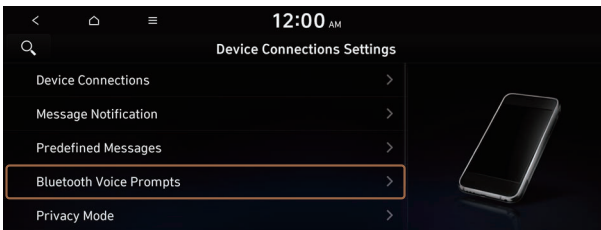

Privacy Mode

Enable or disable Privacy Mode. Hide data including contacts and call history from showing up on the system screen to protect privacy.

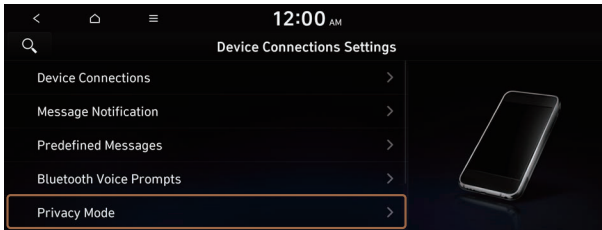

Bluetooth System Info

You can see and edit the Bluetooth information of the system.

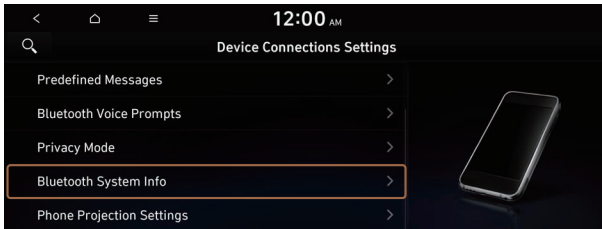

Phone Projection Settings

You can activate the phone projection connection function to pair your smartphone with the system.

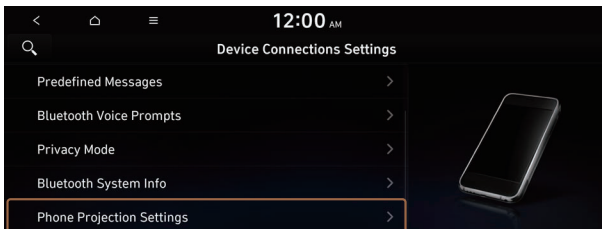

Android Auto

You can activate the Android Auto function to pair your Android smartphone with the system.

Apple CarPlay

You can activate the Apple CarPlay function to pair your iPhone with the system.

Bluetooth (if equipped)

You can register or delete a Bluetooth device for the system and connect or disconnect a registered device. You can also configure operation settings such as notifications, messages, and other settings for Bluetooth devices.



- ✎ For more information on how to use the Bluetooth functions: ► see "Connecting a Bluetooth device."
- ✎ Some setting options appear when a smartphone is connected to the system.
- ✎ To edit or delete a message, park the vehicle at a safe place and access the messaging function on your smartphone. You cannot edit or delete a message from the system.
- ✎ When an iPhone is connected to the system, there are some restrictions when receiving messages as follows:
 - Only the sender name appears when the sender information is saved.
 - Only the phone number appears when the sender information is not saved.
 - You cannot use the auto-reply message function.
 - When the incoming message notification or lock-screen view option is off, messages cannot be received.
- ✎ The message reader function may not be supported depending on the system language.

Bluetooth Connections

You can register or delete a Bluetooth device from the system and connect or disconnect a registered device.

 You can add one Bluetooth hands-free kit or up to two Bluetooth audio devices.

Auto Connection Priority

Set the priority order for automatic Bluetooth connection to the system when it turns on.

 On the device list, press  on the right and drag the item to reposition.

Message Notification

Set to receive message notifications.

 This option may not be available in some phone models.

Predefined Messages

Edit message templates for quick replies.

 This option may not be available in some phone models.

Bluetooth Voice Prompts

Set whether to hear voice prompts for events related to Bluetooth connections.

Privacy Mode

Enable or disable Privacy Mode. Hide data including contacts and call history from showing up on the system screen to protect privacy.

Bluetooth System Info

You can see and edit the Bluetooth information of the system.

Configuring the advanced system settings (Type1) (if equipped)

You can configure the settings for notification and button actions.

- 1 On the All Menus screen, press **Setup ► Advanced**.

The advanced settings screen appears.

- 2 Configure the settings required:

Return to Map: Set Time

You can set the system to automatically display the map screen after a specified period of time when switched to the Radio/Media mode screen while using the navigation.

- ✍ This function works while driving once a destination has been set.
- ✍ This feature is not available on the phone projection screen.
- ✍ The screen may differ depending on the vehicle model and specifications.

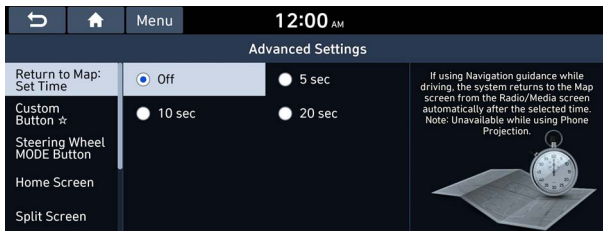

TUNE Knob Function (if equipped)

You can change the Search knob's function on the map.

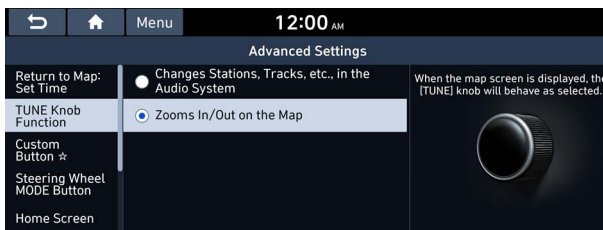

Changes Stations, Tracks, etc., in the Audio System

You can search music or adjust the radio frequency by using the Search knob on the map.

Zooms In/Out on the Map

You can zoom in or out the map by using the Search knob on the map.

Custom Button ☆

You can set the frequently used functions by pressing the custom button on the control panel. Set the frequently used functions as custom buttons to access them easily.

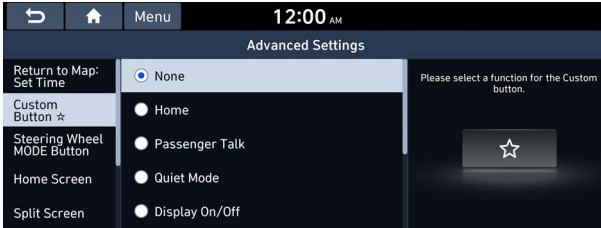

✍ The screen may differ depending on the vehicle model and specifications.

Steering Wheel MODE Button

You can select the media mode to run when the [MODE] button on the steering wheel is pressed.

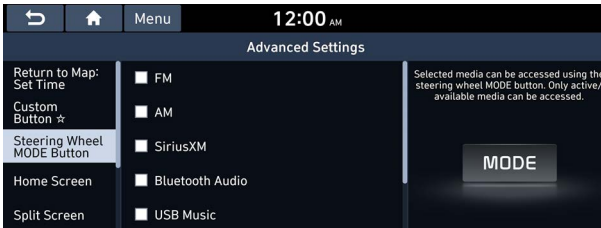

✍ The screen may differ depending on the vehicle model and specifications.

Home Screen

You can change the layout of the Home screen.

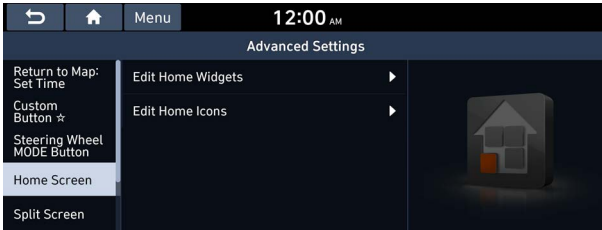

 The screen may differ depending on the vehicle model and specifications.

Edit Home Widgets

You can edit the types and arrangement of home widgets.

 For more information: ► see "Editing widgets on the Home screen (Type1)."

Edit Home Icons

You can edit the arrangement of home icons.

 For more information: ► see "Editing icons on the Home screen (Type1)."

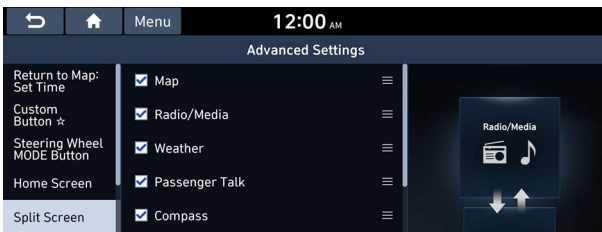

Split Screen (if equipped)

You can specify the items to display on the Split Screen.



 The screen may differ depending on the vehicle model and specifications.

 This option is only available when the display supports Split Screen.

 On the screen list, press  on the right and drag the item to reposition.

My Data

You can import location data from a USB device to the system, or export the data on the system to a USB device.

- ✎ When importing or exporting the location data, you can use only the USB device formatted in exFAT, FAT16/32, or NTFS.
- ✎ The screen may differ depending on the vehicle model and specifications.

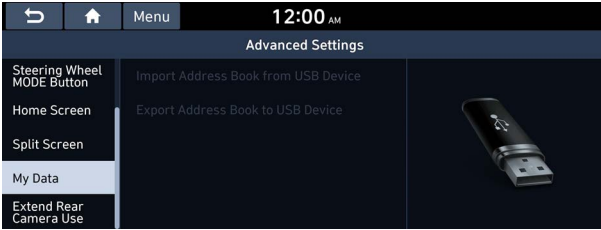

Import Address Book from USB Device

You can import the location data on a USB device to the system.

- ✎ The previous location data on the system is to be deleted.
- ✎ While importing from a navigation system that uses a different coordinate system, the locations may appear differently.

Export Address Book to USB Device

You can export the location data on the system to a USB device.

- ✎ The location data on the USB device is deleted.

Extend Rear Camera Use (if equipped)

You can set to display the rear camera display even when you change the shift position other than "R" (Reverse) after reversing.

- ✎ When you shift to "P" (Park) or drive at a predetermined speed or faster, the rear view display disappears to display the previous screen.

Configuring the button settings (Type1)

You can configure features to activate when pressing buttons on the control panel or steering wheel.

1 On the All Menu screen, press **Setup ► Button**.

The button settings screen appears.

2 Configure the settings required:

✎ Press **Menu ► Search for Settings** or press  and enter a keyword to search for a setting item. You can also search for a setting item by voice.

TUNE Knob Function (if equipped)

You can change the Search knob's function on the map.

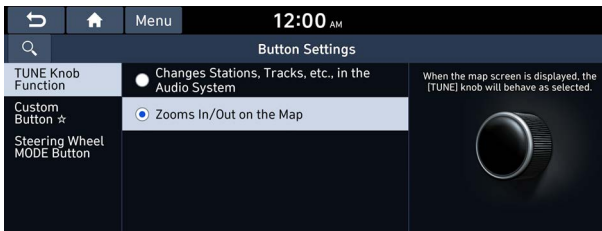

Changes Stations, Tracks, etc., in the Audio System

You can search music or adjust the radio frequency by using the Search knob on the map.

Zooms In/Out on the Map

You can zoom in or out the map by using the Search knob on the map.

Custom Button ☆

You can set the frequently used functions by pressing the custom button on the control panel. Set the frequently used functions as custom buttons to access them easily.

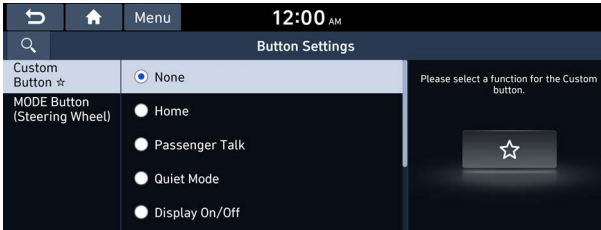

✍ The screen may differ depending on the vehicle model and specifications.

MODE Button (Steering Wheel)

You can select the media mode to run when the [MODE] button on the steering wheel is pressed.

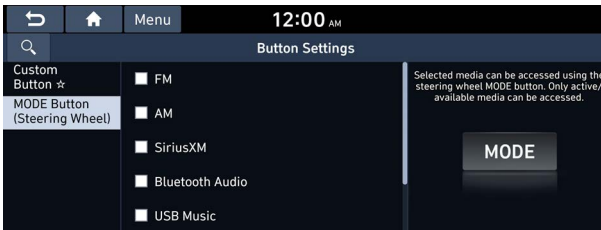

✍ The screen may differ depending on the vehicle model and specifications.

Configuring the button settings (Type2)

You can configure features to activate when pressing buttons on the control panel or steering wheel.

1 On the All Menus screen, press **Setup ► Button**.

The button settings screen appears.

2 Configure the settings required:

✍ Press **☰ ► Search for Settings** or press **🔍** and enter a keyword to search for a setting item. You can also search for a setting item by voice.

Left N Button (Steering Wheel) (if equipped)

Specify the functions that can be activated by pressing the N button on the steering wheel. Set the frequently used functions as N button functions to access them easily.

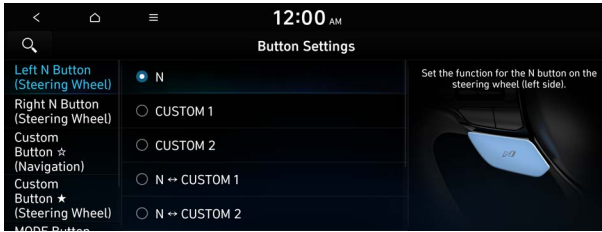

 The screen may differ depending on the vehicle model and specifications.

Right N Button (Steering Wheel) (if equipped)

Specify the functions that can be activated by pressing the N button on the steering wheel. Set the frequently used functions as N button functions to access them easily.

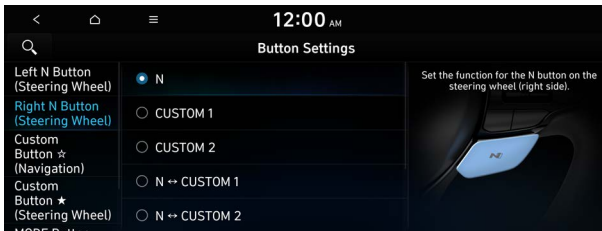

 The screen may differ depending on the vehicle model and specifications.

Custom Button ☆ (Navigation) (if equipped)

You can set the frequently used functions by pressing the custom button on the control panel. Set the frequently used functions as custom buttons to access them easily.



 The screen may differ depending on the vehicle model and specifications.

Custom Button ★ (Steering Wheel) (if equipped)

Specify the functions that can be activated by pressing the user button on the steering wheel. Set the frequently used functions as custom buttons to access them easily.



 The screen may differ depending on the vehicle model and specifications.

MODE Button (Steering Wheel)

You can select the media mode to run when the [MODE] button on the steering wheel is pressed.

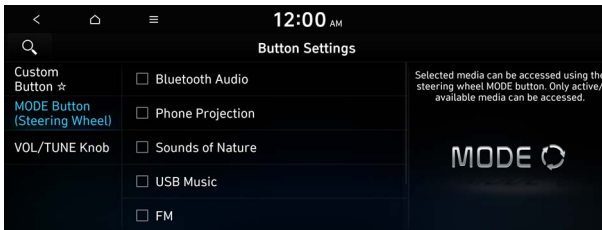

 The screen may differ depending on the vehicle model and specifications.

VOL/TUNE Knob (if equipped)

You can switch the functions of the Volume and Tune knobs.



Option A

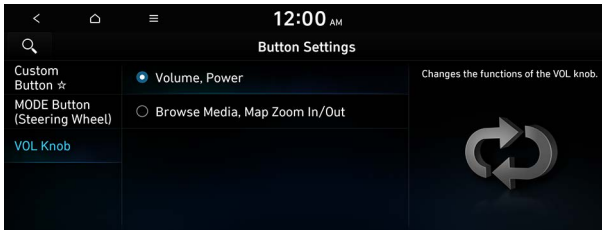

Option B

 The screen may differ depending on the vehicle model and specifications.

Configuring the sound settings (Type1)

You can change the sound settings such as speaker volume and sound effects.

- ✍ Available settings may differ depending on the vehicle model and specifications.
- ✍ Some functions may not be available depending on the infotainment system and amplifier specifications on the vehicle.

1 On the All Menus screen, press **Setup ► Sound**.

The sound settings screen appears.

2 Configure the settings required:

- ✍ Press **Menu ► Search for Settings** or press  and enter a keyword to search for a setting item. You can also search for a setting item by voice.

Premium Sound (if equipped)

You can change the system sound settings and apply various sound effects.

- ✍ Available sound effects may differ depending on the specifications of the amplifier.

Live Dynamic (if equipped)

Provides natural and vivid sound like real performance.

Bass Boost (if equipped)

Provides magnificent and dynamic sound by amplifying the bass.

Quantum Logic Surround (if equipped)

Provides the surround sound that can give spatial depth of field as on an actual stage.

Centerpoint® Surround Technology (if equipped)

Provides rich surround sound after converting the sound sources such as digital files and satellite radio to stereophonic sound.

Sound Tuning

You can adjust the sound by adjusting the strengths (output levels) for each audio band: Bass, Midrange, and Treble. You can also configure settings so that sound is audible more loudly and clearly at a specific location in the vehicle.

 To reset all audio settings to the default values, press **Center**.

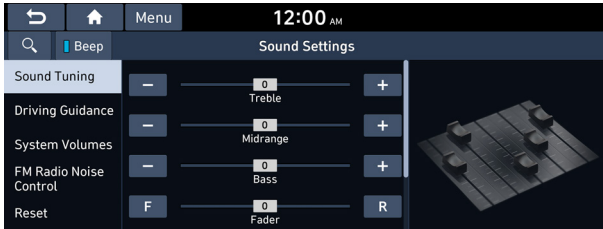

Driving Guidance

Specify the system's guidance voice type, set a certain sound to override other sounds, and configure other guidance sound settings.

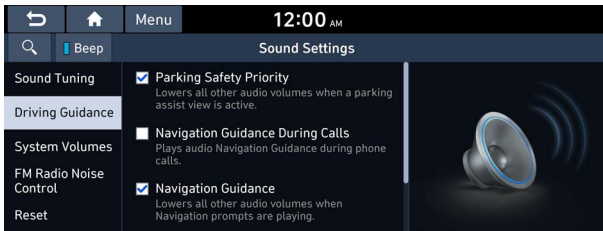

Parking Safety Priority

When warning sound is generated while parking, the audio volume decreases to make the sound audible.

Navigation Guidance During Calls

Even during a call, the navigation sound is heard.

Navigation Guidance

You can set to enable the navigation sound to be heard first when using both the navigation system and Radio/Media system.

Mute Navigation Guidance

Press the Mute button on the steering wheel when the navigation guidance is being output to set to mute the guidance volume for 10 seconds.

System Volumes

You can adjust the volume for each system function including phone projection.

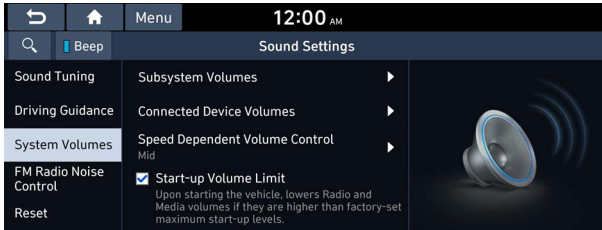

Subsystem Volumes

You can adjust the volume for each system function and initialize all volume settings.

To initialize all system sound settings, press **Reset**.

Connected Device Volumes

You can adjust the volume of the phone projection and initialize all volume settings.

- **Android Auto:** Vary the volume of your Android smartphone, connected to the system, depending on the function.
- **Apple CarPlay:** Vary the volume of your iPhone, connected to the system, depending on the function.

To initialize all system sound settings of the phone projection, press **Reset**.

Speed Dependent Volume Control (if equipped)

Automatically adjusts Audio volume according to vehicle speed.

Start-up Volume Limit

You can set to automatically decrease the audio volume to an adequate level when turning on the vehicle.

Dynamic Speed Compensation (if equipped)

Provides a stable listening environment by adjusting the audio volume depending on the vehicle speed.

FM Radio Noise Control

You can customize sound quality when listening to FM radio by adjusting background noise of the original sound.

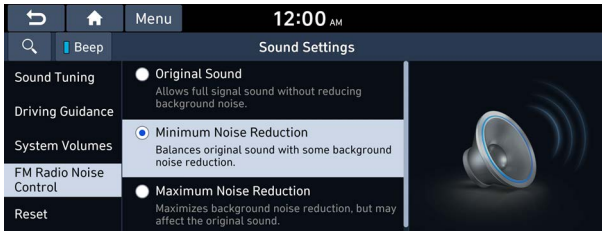

Active Sound Design (if equipped)

You can turn on or off the engine sound function which generates a virtual engine sound.

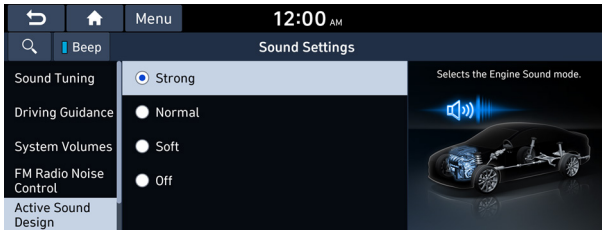

 The screen may differ depending on the vehicle model and specifications.

Reset

You can initialize all the sound settings.

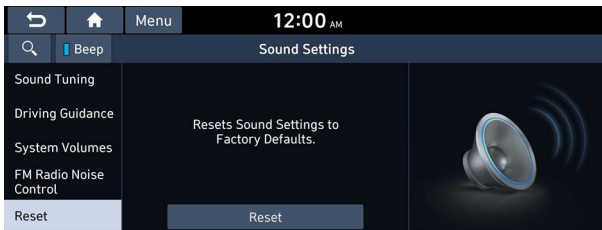

Turning on/off the screen touch sound

To turn on or off the touch sound on the screen, press **Beep** at the top of the screen.

Configuring the sound settings (Type2)

You can change the sound settings such as speaker volume and sound effects.

- ✎ Available settings may differ depending on the vehicle model and specifications.
- ✎ Some functions may not be available depending on the infotainment system and amplifier specifications on the vehicle.

1 On the All Menus screen, press **Setup ► Sound**.

The sound settings screen appears.

2 Configure the settings required:

- ✎ Press **☰ ► Search for Settings** or press **🔍** and enter a keyword to search for a setting item. You can also search for a setting item by voice.

Premium Sound (if equipped)

You can change the system sound settings and apply various sound effects.

- ✎ Available sound effects may differ depending on the specifications of the amplifier.

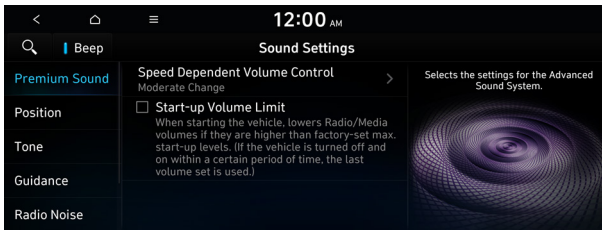

Speed Dependent Volume Control

Automatically adjusts Audio volume according to vehicle speed.

Start-up Volume Limit

You can set to automatically decrease the audio volume to an adequate level when turning on the vehicle.

Live Dynamic (if equipped)

Provides natural and vivid sound like real performance.

Bass Boost (if equipped)

Provides magnificent and dynamic sound by amplifying the bass.

Quantum Logic Surround (if equipped)

Provides the surround sound that can give spatial depth of field as on an actual stage.

Centerpoint® Surround Technology (if equipped)

Provides rich surround sound after converting the sound sources such as digital files and satellite radio to stereophonic sound.

Position

You can select a position where sound is more audible in the vehicle. By pressing the desired point on the seat image or pressing the arrow buttons, you can finely adjust the position. To concentrate the sound to the center of the vehicle, press .

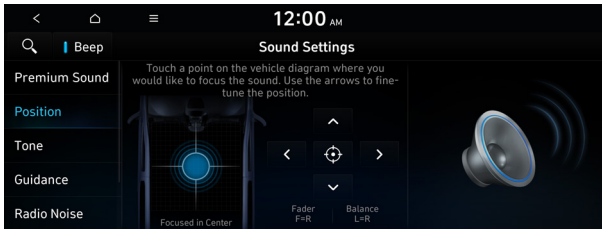

Tone

You can adjust the sound by adjusting the strengths (output levels) for each audio band: Bass, Midrange, and Treble.

 To reset all audio settings to the default values, press **Center**.

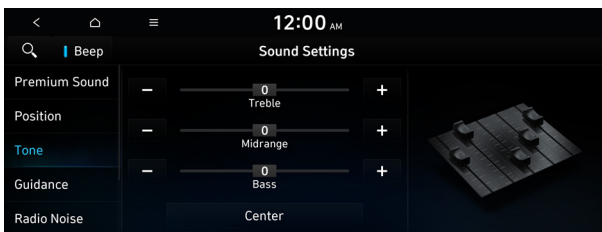

Guidance

Specify the system's guidance voice type, set a certain sound to override other sounds, and configure other guidance sound settings.



Guidance Volumes

You can adjust the volume levels for individual system features or initialize all volume settings.

 To initialize all system sound settings, press **Reset**.

Navigation Voice Guidance (if equipped)

You can configure the navigation voice guidance feature.

- **Mute voice navigation nearby Destination:** If the set destination is a registered location, voice guidance is turned off when the vehicle gets closer to the destination.

Navigation Alert (if equipped)

You can set to activate drive assist features when needed for safety.

- **Camera Alert Distance:** You can set when to receive alerts against and voice descriptions about traffic enforcement cameras.

Navigation Guidance During Calls

Even during a call, the navigation sound is heard.

Navigation Volume Priority

You can set to enable the navigation sound to be heard first when using both the navigation system and Radio/Media system.

Mute Navigation Guidance

Press the Mute button on the steering wheel when the navigation guidance is being output to set to mute the guidance volume for 10 seconds.

Active Sound (if equipped)

You can turn on the engine sound effect function which plays engine sound.



Active Sound Design

Adjust the interior engine sound volume.

Virtual Engine Sound System

Turn on or off the engine sound function which generates a virtual engine sound.

Radio Noise

You can customize sound quality when listening to FM radio by adjusting background noise of the original sound.

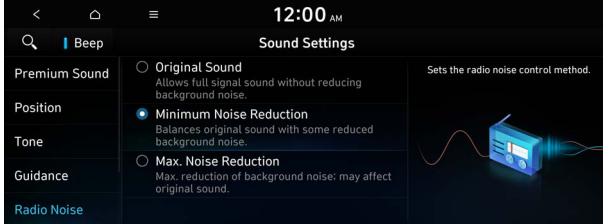

Driver Assistance (if equipped)

You can set to give priority to the proximity warning feature and lower all other sounds when parking your vehicle.



Driving Safety Priority (if equipped)

When warning sound is generated while driving, the audio volume decreases to make the sound audible.

Parking Safety Priority

When warning sound is generated while parking, the audio volume decreases to make the sound audible.

High (if equipped)

Sets the warning volume to High.

Medium (if equipped)

Sets the warning volume to Medium.

Low (if equipped)

Sets the warning volume to Low.

Off (if equipped)

Turns off the warning sound.

Connected Devices (if equipped)

You can adjust the volume of the phone projection and initialize all volume settings.



Android Auto

Vary the volume of your Android smartphone, connected to the system, depending on the function.

🔗 To initialize all system sound settings of the phone projection, press **Reset**.

Apple CarPlay

Vary the volume of your iPhone, connected to the system, depending on the function.

🔗 To initialize all system sound settings of the phone projection, press **Reset**.

Turning on/off the screen touch sound

To turn on or off the touch sound on the screen, press **Beep** at the top of the screen.

Configuring the voice recognition settings (Type1)

You can change the settings for voice recognition.

1 On the All Menus screen, press **Setup ► Voice Recognition**.

The voice recognition settings screen appears.

2 Configure the settings required:

🔗 Press **Menu ► Search for Settings** or press  and enter a keyword to search for a setting item. You can also search for a setting item by voice.

Voice Recognition Guidance

You can set whether to hear the voice recognition guidance briefly or in detail. You can also turn off the voice guidance.

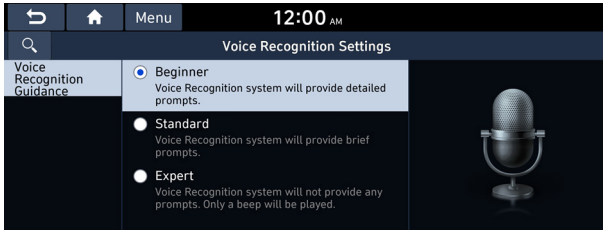

Configuring the voice recognition settings (Type2)

You can change the settings for voice recognition.

1 On the All Menus screen, press **Setup ► Voice Recognition**.

The voice recognition settings screen appears.

2 Configure the settings required:

✎ Press **☰ ► Search for Settings** or press **🔍** and enter a keyword to search for a setting item. You can also search for a setting item by voice.

Audible Prompts

You can set whether to hear the voice recognition guidance briefly or in detail. You can also turn off the voice guidance.

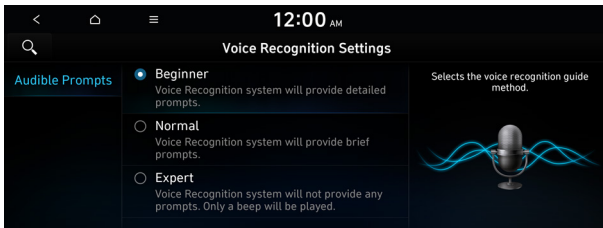

Configuring the navigation settings (Type1)

You can configure the navigation settings for navigation operations, screen display, voice guidance, etc. You can also export or import the location data.

✍ For details on how to use navigation functions, see the "Navigation" chapter.
▶ See "Navigation."

1 On the All Menus screen, press **Setup ▶ Navigation**.

The navigation settings screen appears.

2 Configure the settings required:

✍ Press **Menu ▶ Search for Settings** or press  and enter a keyword to search for a setting item. You can also search for a setting item by voice.

Display

You can specify the information to display on the navigation map screen.



✍ The screen may differ depending on the vehicle model and specifications.

Map

You can specify the items to display on the map.

- **Map Font Size:** You can set the size of the screen font on the navigation map.
- **Map Color:** You can set the navigation map theme color.
- **Map Display:** You can specify the items to display on the map.
 - **Map View:** Set the navigation map display mode. To automatically rotate the map screen based on the driving direction, select **2D Heading Up**. To fix the top of the map screen to north, select **2D North Up**. If you select **3D Map**, the map screen is displayed in 3D mode and automatically rotates based on the driving direction.
 - **Display Traffic:** Displays nearby traffic information on the map.
 - **3D Buildings:** Displays major buildings on the map in three dimensions.
 - **Auto-scale:** Automatically changes the scale of the map.

- **POI Display:** You can specify the icon type to display nearby places on the map.
- ✍ Press  on the right side of Gas/LPG Station to select display options for fuel prices.
 - Gas and LPG stations on the Map screen will also show their fuel prices if they are lower than the set price.
 - Select **Display Fuel Price Info on Map** to view recommended fuel prices based on the prices offered in the area.
 - Fuel prices on the map may differ from actual ones.

Information

You can specify the information to display on the navigation map screen while driving.

- **Route Guide Line:** Change the route guide line color depending on the traffic conditions. To display the route guide line with a fixed color, uncheck **Show Traffic Colors on Route** and select a color.
- **Vehicle Symbol:** You can specify the icon type to display your current location on the map.
- **Units:** You can set the distance unit of the navigation map to **Kilometers (km)** or **Miles (mi)** (if equipped).
- **Show Vehicle Speed:** Displays the vehicle speed on the map.
- **Detailed Guidance View:** You can set to display detailed information on the Map screen, such as moving directions and lane change.
- **Speed Limits:** Sets whether or not to display the speed limits on the screen.

Map Auto-scale Settings

You can set the scales for each vehicle speed zone.

- ✍ For example, when "100 m" is selected for the "33–64 km/h" zone and "200 m" for the "65–97 km/h" zone, the map scale on the navigation screen becomes 100 m when vehicle speed is 64 km/h and 200 m when vehicle speed is 65 km/h.

Return to Map: Set Time

You can set the system to automatically display the map screen after a specified period of time when switched to the Radio/Media mode screen while using the navigation.

- ✍ This function works while driving once a destination has been set.
- ✍ This feature is not available on the phone projection screen.

Auto Re-center Map

You can set the system to automatically display the current position when the specified period of time elapses after changing to another position on the map.

Guidance

You can configure the navigation guidance settings.

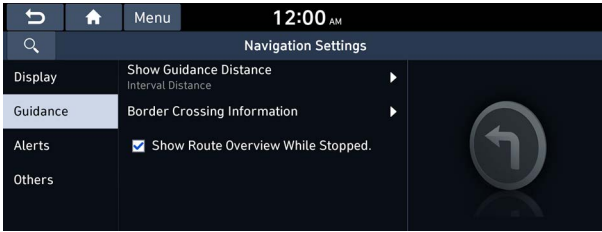

 The screen may differ depending on the vehicle model and specifications.

Show Guidance Distance

You can configure settings for displaying the distance to the destination during guidance.

- **Interval Distance:** Displays the distance as the one between different zones.
- **Cumulative Distance:** Displays the distance as the one between the current position and target position.

Border Crossing Information

You can set whether or not to display the border crossing information on the screen.

Show Route Overview While Stopped.

You can set to display the route overview from the start point to the destination when the vehicle is stationary.

Alerts

You can set to activate drive assist features when needed for safety.

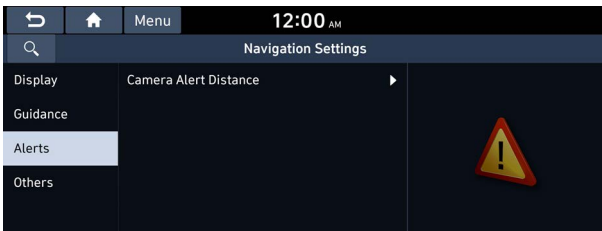

Warning

Be sure to check the road conditions while driving, because the camera information may get changed occasionally after a map update to the latest version. Relying solely on the driving assist system may cause violation of traffic rules and regulations, resulting in an accident.

Camera Alert Distance

You can set when to receive alerts against and voice descriptions about traffic enforcement cameras.

- **Camera Alerts with Navigation Muted:** You can set traffic enforcement camera alerts or warning sounds for safe driving when the navigation is muted.
 - **None:** No guidance is provided when the navigation is muted.
 - **Use Beeps Only:** Guidance is provided only with warning sound.
 - **Use Voice Prompts with Beeps:** Guidance is provided with warning sound and voice.
- **Camera Alert Distance Depending on the Vehicle Speed:** The time when to get alerts for traffic enforcement cameras is automatically set depending on the driving speed. When the **Camera Alert Distance Depending on the Vehicle Speed** function is off, the time when to get guidance on traffic enforcement cameras on **Local Roads** and **Highway** can be selected.

Others

You can configure navigation options, e.g., turning on or off fuel prices, exporting or importing places from and to Address Book.

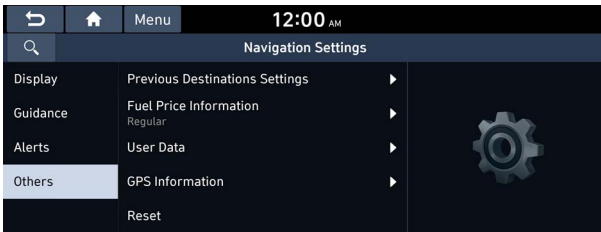

 The screen may differ depending on the vehicle model and specifications.

Previous Destinations Settings

You can set to automatically save the previous destination and display the previous destinations when the navigation system starts.

- **Save Previous Destinations:** The previous destination is automatically saved.
- **Show Previous Destinations after Navigation Start-up:** When the navigation system starts, the list of recent destinations appear on a pop-up window.

Fuel Price Information (if equipped)

When displaying gas stations or LPG charging stations on the map, the fuel prices below a specific range can be displayed.

- ✍ Select **Display Fuel Price Info on Map** to view recommended fuel prices based on the prices offered in the area.
- ✍ Fuel prices on the map may differ from actual ones.

User Data

You can import location data from a USB device to the system, or export the data on the system to a USB device.

- ✍ When importing or exporting the location data, you can use only the USB device formatted in exFAT, FAT16/32, or NTFS.
- **Import Address Book/Previous Destinations from USB:** You can import registered location and destination information, saved on your USB storage device, to the system.
 - ✍ Previous information saved on the system will be deleted.
 - ✍ If location information is imported from a different navigation device or system, the locations may appear differently because the device/system uses a different coordinate system.
- **Export Address Book/Previous Destinations to USB:** You can export registered location and destination information, saved on the system, to your USB storage device.
 - ✍ Previous information saved on the USB storage device will be deleted.

GPS Information

You can see the GPS satellite status and coordinates of the current position.

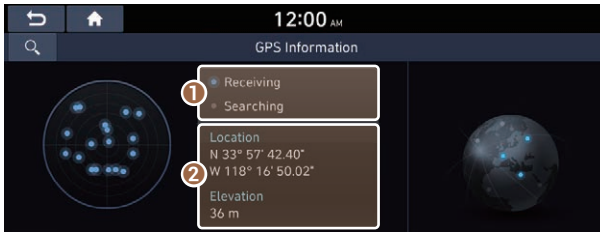

The following information appears:

- 1 Can see the reception status of the satellite signals.
 - **Receiving:** Satellite signals are being received and the current position is recognized.
 - **Searching:** The system is scanning the satellite signals.
- 2 Can see the current location.

Reset

You can initialize all the settings of the navigation system.

Configuring the navigation settings (Type2)

You can configure the navigation settings for navigation operations, screen display, voice guidance, etc. You can also export or import the location data.

 For details on how to use navigation functions, see the "Navigation" chapter. ► [See "Navigation."](#)

- 1 On the All Menus screen, press **Setup ► Navigation**.

The navigation settings screen appears.

- 2 Configure the settings required:

 Press  ► **Search for Settings** or press  and enter a keyword to search for a setting item. You can also search for a setting item by voice.

Display

You can specify the information to display on the navigation map screen.

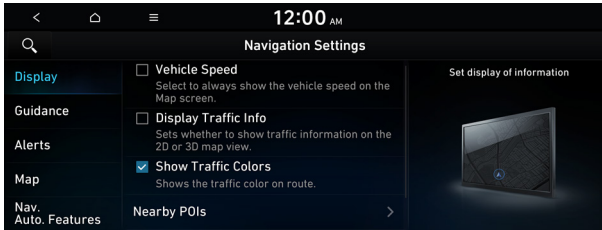

 The screen may differ depending on the vehicle model and specifications.

Vehicle Speed

Displays the vehicle speed on the map.

Display Traffic Info



Displays nearby traffic information on the map.

Show Traffic Colors

Used to display the route guide line colors depending on the traffic conditions.

Nearby POIs

You can specify the icon type to display nearby places on the map.

-  Press  on the right side of Gas/LPG Station to select display options for fuel prices.
- Gas and LPG stations on the Map screen will also show their fuel prices if they are lower than the set price.
 - Select **Show Fuel Price Information on the Map** to view recommended fuel prices based on the prices offered in the area.
 - Fuel prices on the map may differ from actual ones.

Fuel Price Info (if equipped)

When displaying gas stations or LPG charging stations on the map, the fuel prices below a specific range can be displayed.

- ✎ Select **Show Fuel Price Information on the Map** to view recommended fuel prices based on the prices offered in the area.
- ✎ Fuel prices on the map may differ from actual ones.

Guidance

You can configure the navigation guidance settings.



- ✎ The screen may differ depending on the vehicle model and specifications.

Detailed Guidance

You can specify the information to display on the navigation map screen while driving.

- **Detailed Guidance View:** You can set to display detailed information on the Map screen, such as moving directions and lane change.
- **Speed Limits:** Sets whether or not to display the speed limits on the screen.
- **Units:** You can set the distance unit of the navigation map to **Kilometers (km)** or **Miles (mi)** (if equipped).

Set Type of Guide Distance

You can configure settings for displaying the distance to the destination during guidance.

- **Interval Distance:** Displays the distance as the one between different zones.
- **Cumulative Distance:** Displays the distance as the one between the current position and target position.

Navigation Voice Guidance

You can configure the navigation voice guidance feature.

- **Mute voice navigation nearby Destination:** If the set destination is a registered location, voice guidance is turned off when the vehicle gets closer to the destination.

Border Crossing Information

You can set whether or not to display the border crossing information on the screen.

Show Route Overview While Stopped

You can set to display the route overview from the start point to the destination when the vehicle is stationary.

Previous Destinations Settings

You can set to automatically save the previous destination and display the previous destinations when the navigation system starts.

- **Save Previous Destinations:** The previous destination is automatically saved.
- **Show Previous Destinations after Navigation Start-up:** When the navigation system starts, the list of recent destinations appear on a pop-up window.

 To use this feature, your home or office must have been registered as a favorite. In Go Home or Office under **Navigation Menu** ► **Saved Places** ► **Favorites**, register the location information.

Alerts

You can set to activate drive assist features when needed for safety.

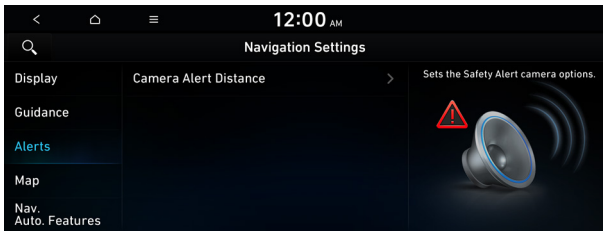

 The screen may differ depending on the vehicle model and specifications.

Warning

Be sure to check the road conditions while driving, because the camera information may get changed occasionally after a map update to the latest version. Relying solely on the driving assist system may cause violation of traffic rules and regulations, resulting in an accident.

Camera Alert Distance

You can set when to receive alerts against and voice descriptions about traffic enforcement cameras.

- **Camera Alert Distance Depending on the Speed Limit:** The time when to get alerts for traffic enforcement cameras is automatically set depending on the driving speed. When the **Camera Alert Distance Depending on the Speed Limit** function is off, the time when to get guidance on traffic enforcement cameras on **Local Roads** and **Freeway** can be selected.

Map (if equipped)

You can specify the items to display on the map.



 The screen may differ depending on the vehicle model and specifications.

Map Mode

You can specify the items to display on the map.

- **Map View:** Set the navigation map display mode. To fix the top of the map screen to north, select **North Up 2D**. To automatically rotate the map screen based on the driving direction, select **Heading Up 2D**. If you select **3D Map**, the map screen is displayed in 3D mode and automatically rotates based on the driving direction.
- **3D Buildings:** Displays major buildings on the map in three dimensions.
- **Auto-scale:** Automatically changes the scale of the map.

Map Font Size

You can set the size of the screen font on the navigation map.

Map Color (if equipped)

You can set the navigation map theme color.

Vehicle Symbol Color

You can specify the icon type to display your current location on the map.

Set Map Auto-scale

You can set the scales for each vehicle speed zone.

 For example, when "200 m" is selected for the "31–65 km/h" zone and "400 m" for the "66–95 km/h" zone, the map scale on the navigation screen becomes 200 m when vehicle speed is 65 km/h and 400 m when vehicle speed is 66 km/h.

Nav. Auto Features

You can configure navigation options, e.g., turning on or off fuel prices, exporting or importing places from and to Saved Places.



 The screen may differ depending on the vehicle model and specifications.

Auto Re-center Map

You can set the system to automatically display the current position when the specified period of time elapses after changing to another position on the map.

Return to Map: Timing

You can set the system to automatically display the map screen after a specified period of time when switched to the Radio/Media mode screen while using the navigation.

 This function works while driving once a destination has been set.

 This feature is not available on the phone projection screen.

User Data

You can import location data from a USB device to the system, or export the data on the system to a USB device.

✎ When importing or exporting the location data, you can use only the USB device formatted in exFAT, FAT16/32, or NTFS.

- **Import Saved Places/Previous Destinations from USB:** You can import registered location and destination information, saved on your USB storage device, to the system.

✎ Previous information saved on the system will be deleted.

✎ If location information is imported from a different navigation device or system, the locations may appear differently because the device/system uses a different coordinate system.

- **Export Saved Places/Previous Destinations to USB:** You can export registered location and destination information, saved on the system, to your USB storage device.

✎ Previous information saved on the USB storage device will be deleted.

GPS Information

You can see the GPS satellite status and coordinates of the current position.

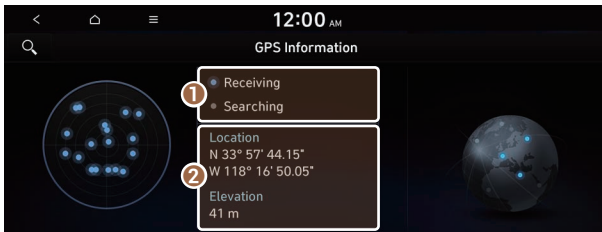

✎ The screen may differ depending on the vehicle model and specifications.

The following information appears:

- 1 Can see the reception status of the satellite signals.
 - **Receiving:** Satellite signals are being received and the current position is recognized.
 - **Searching:** The system is scanning the satellite signals.
- 2 Can see the current location.

Configuring the Bluelink settings (Type1)

You can subscribe to the Blue Link service or see the modem information.

- 1 On the All Menus screen, press **Setup ► Blue Link**.

The Blue Link settings screen appears.

- 2 Configure the settings required:

✎ Press **Menu ► Search for Settings** or press  and enter a keyword to search for a setting item. You can also search for a setting item by voice.

Feature Enrollment

You can subscribe to the Blue Link service by using the Blue Link settings menu.

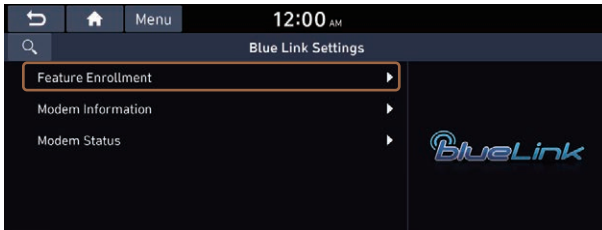

✎ For more information: ► see "Subscribing to the service."

Modem Information

You can check the modem information for use of the Blue Link service.

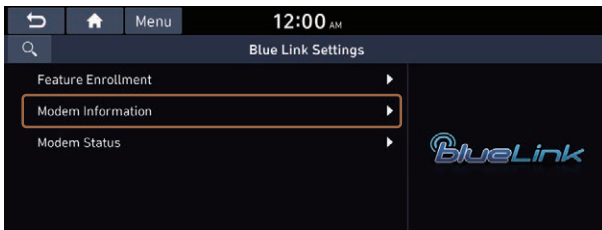

Modem Status

You can check the modem status for use of the Blue Link service.

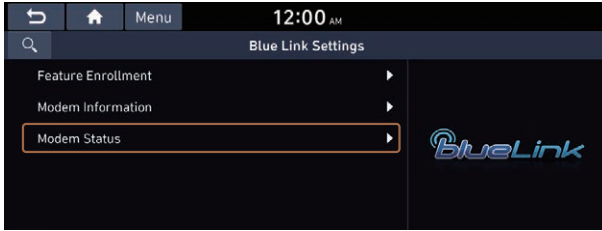

Configuring the Bluelink settings (Type2)

You can subscribe to the Bluelink service or see the modem information.

- 1 On the All Menus screen, press **Setup ► Bluelink**.

The Bluelink settings screen appears.

- 2 Configure the settings required:

✎ Press **☰ ► Search for Settings** or press **🔍** and enter a keyword to search for a setting item. You can also search for a setting item by voice.

Feature Enrollment

You can subscribe to the Bluelink service by using the Bluelink settings menu.

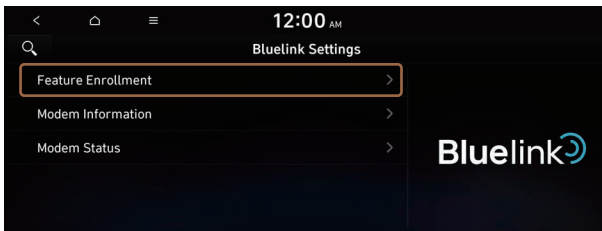

✎ For more information: ► see "Subscribing to the service."

Modem Information

You can check the modem information for use of the Bluelink service.

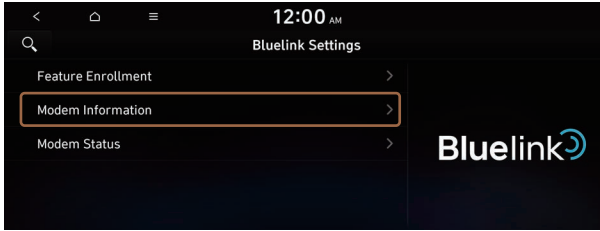

Modem Status

You can check the modem status for use of the Bluelink service.

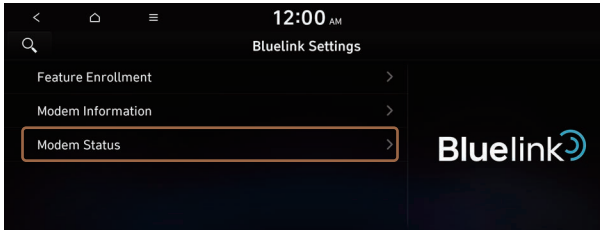

Configuring the user profile settings (Type1) (if equipped)

You can additionally set profiles for each driver after First Run Setup.

1 On the All Menus screen, press **Setup ► User Profile**.

2 Press the user to change its profile.

The User Profile Settings screen appears.

✎ Press **Menu ► Search for Settings** or press  and enter a keyword to search for a setting item. You can also search for a setting item by voice.

✎ Press **Change User** to switch to another user's profile.

✎ When you log in as guest, you cannot set the profile items additionally. To set a different profile, select another user.

Profile Settings

You can specify the details and operation environment for a registered user.

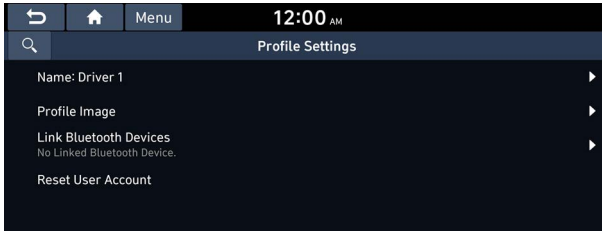

Name

You can specify the name of the user to display on the profile.

Profile Image

You can specify the image to display on the user profile.

Link Bluetooth Devices

You can connect any registered Bluetooth device. ► See "[Connecting a Bluetooth device.](#)"

Reset User Account

You can initialize all account settings.

Configuring the user profile settings (Type2)

You can additionally set profiles for each driver after First Run Setup.

1 On the All Menus screen, press **Setup ► User Profile**.

2 Press the user to change its profile.

The User Profile Settings screen appears.

✎ Press **☰ ► Search for Settings** or press **🔍** and enter a keyword to search for a setting item. You can also search for a setting item by voice.

✎ Press **Change User** to switch to another user's profile.

✎ When you log in as guest, you cannot set the profile items additionally. To set a different profile, select another user.

Profile Settings

You can specify the details and operation environment for a registered user.



Name

You can specify the name of the user to display on the profile.

Profile Image

You can specify the image to display on the user profile.

Link Bluelink Account

You can use various services and convenient management features when linked to the registered Bluelink service.

 Subscribe to Bluelink to check the function. ► See "[Subscribing to the service.](#)"

Delete Profile (if equipped)

All stored data and profile settings will be lost and the system will be reset.

Configuring the general system settings (Type1)

You can configure general settings for date, time, language, and the like. You can also check information of the system.

- 1 On the All Menus screen, press **Setup ▶ General**.

The general settings screen appears.

- 2 Configure the settings required:

✎ Press **Menu ▶ Search for Settings** or press  and enter a keyword to search for a setting item. You can also search for a setting item by voice.

SW Info/Update

You can see the versions of system components. You can also update the system to the latest version.

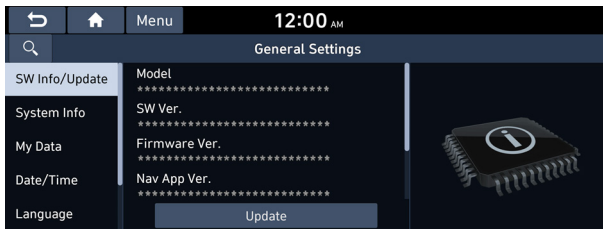

✎ For details on how to update the system software: ▶ see "How to Update the Map and Software for your Infotainment System."

System Info

You can check the system storage space. You can also use your smartphone to access the online user's manual of the system, or initialize all system settings to default values.

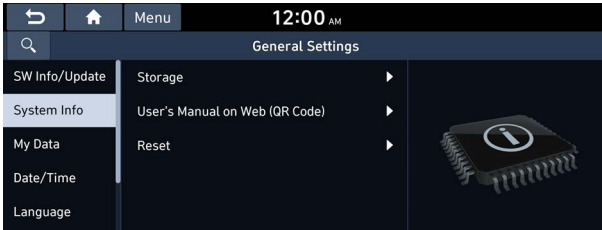

Storage

You can check the storage space of the system memory where voice memos can be saved.

User's Manual on Web (QR Code)

You can access the online user's manual of the system by scanning the QR code with your smartphone.

Reset

You can initialize all system settings including general settings and navigation settings.

 You can also initialize all settings of the login profile.

Caution

- When initialization is performed, all user data in the system including the location data is deleted.
- When phone projection is active, you cannot reset the system settings. To reset the settings, remove the USB cable from your system.

My Data

You can import location data from a USB device to the system, or export the data on the system to a USB device.

- ✎ When importing or exporting the location data, you can use only the USB device formatted in exFAT, FAT16/32, or NTFS.
- ✎ The screen may differ depending on the vehicle model and specifications.

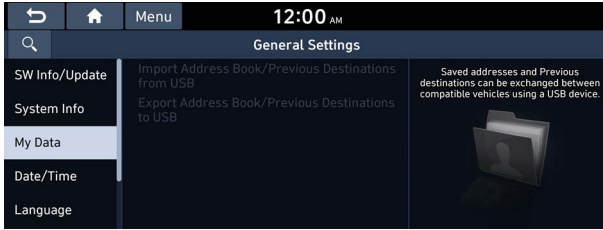

Import Address Book/Previous Destinations from USB

You can import registered location and destination information, saved on your USB storage device, to the system.

- ✎ The previous location data on the system is to be deleted.
- ✎ While importing from a navigation system that uses a different coordinate system, the locations may appear differently.

Export Address Book/Previous Destinations to USB

You can export registered location and destination information, saved on the system, to your USB storage device.

- ✎ Previous information saved on the USB storage device will be deleted.

Date/Time

You can set the system date and time automatically or manually. You can also set the time display mode.

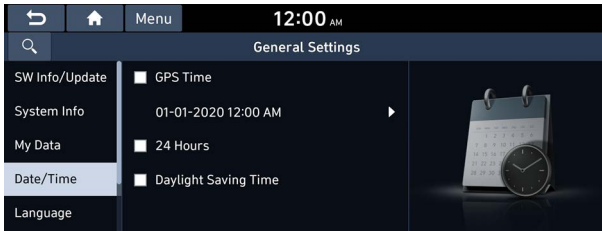

 The screen may differ depending on the vehicle model and specifications.

GPS Time

After receiving the time from GPS, it sets the system date and time automatically.

 To manually set the date and time, uncheck **GPS Time**, press the current date and time below **GPS Time**, and then set the date and time.

24 Hours

The system time is displayed in the 24-hour format.

Daylight Saving Time

Displays the system time in the format of Daylight Saving Time.

Language

You can set the system display language.

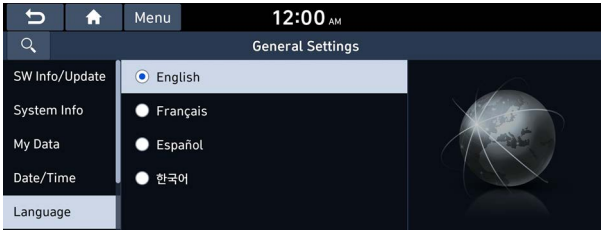

- ✍ The screen may differ depending on the vehicle model and specifications.
- ✍ Once the language has been changed, it takes a while to apply the new language to the system. The notification pop-up window appears as soon as the new language is applied to the system. When you wait a while or press anywhere outside the pop-up window, the window automatically disappears.
- ✍ When you change the system language, it does not affect the display of other unique data such as MP3 music file name.
- ✍ Depending on the system language, the Bluetooth phone message view and voice recognition may not be supported.

Keyboard

You can change the keyboard type for each language to use when entering the text.

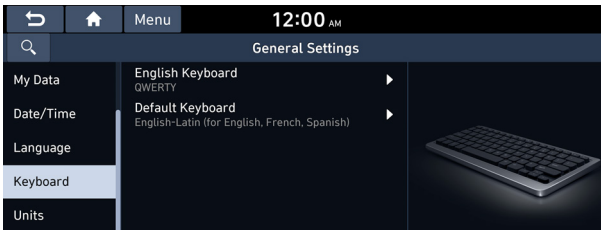

- ✍ The screen may differ depending on the vehicle model and specifications.

English Keyboard

You can select the keyboard type to use when entering the English text.

Default Keyboard

You can select the default keyboard type.

Units (if equipped)

You can specify the units to display on the system screen.

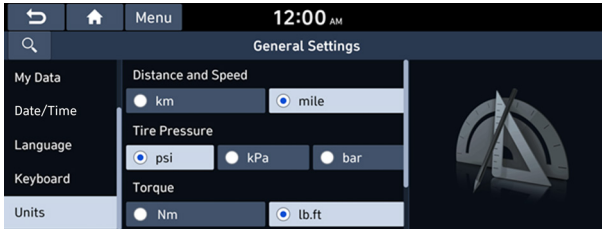

Distance and Speed

You can select the units for distance and vehicle speed to display on the screen.

Temperature

You can select the temperature unit to display on the screen.

Fuel Efficiency

You can select the unit for fuel economy to display on the screen.

Tire Pressure

You can select the unit for tire pressure to display on the screen.

Torque (if equipped)

You can select a torque unit to display on the system screen.

Turbo Boost (if equipped)

You can select a turbo boost unit to display on the system screen.

Configuring the general system settings (Type2)

You can configure general settings for date, time, language, and the like. You can also check information of the system.

1 On the All Menus screen, press **Setup ► General**.

The general settings screen appears.

2 Configure the settings required:

✎ Press **☰ ► Search for Settings** or press **🔍** and enter a keyword to search for a setting item. You can also search for a setting item by voice.

SW Info/Update

You can see the versions of system components. You can also update the system to the latest version.



✎ For details on how to update the system software: ► see "[How to Update the Map and Software for your Infotainment System.](#)"

System Info

You can check the system storage space. You can also use your smartphone to access the online user's manual of the system.

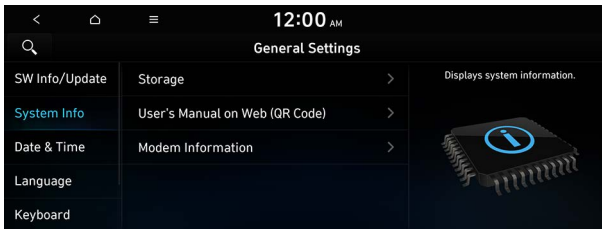

Storage

You can check the storage space of the system memory where voice memos can be saved.

User's Manual on Web (QR Code)

You can access the online user's manual of the system by scanning the QR code with your smartphone.

Modem Information (if equipped)

You can check the modem information for use of the Bluelink service.

What's New (if equipped)

You can see the latest system update information.

- ✍ After update is completed, the system will display the main update items on the screen. Scan the QR code to view the update announcement.

My Data (if equipped)

You can import location data from a USB device to the system, or export the data on the system to a USB device.

- ✍ When importing or exporting the location data, you can use only the USB device formatted in exFAT, FAT16/32, or NTFS.

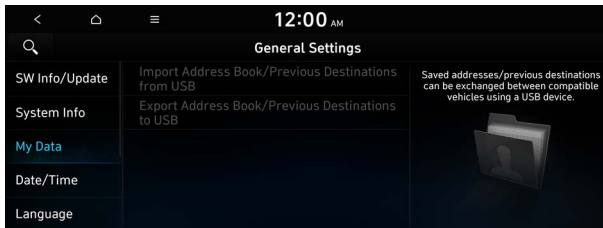

Import Address Book/Previous Destinations from USB

You can import registered location and destination information, saved on your USB storage device, to the system.

- ✍ Previous information saved on the system will be deleted.
- ✍ While importing from a navigation system that uses a different coordinate system, the locations may appear differently.

Export Address Book/Previous Destinations to USB

You can export registered location and destination information, saved on the system, to your USB storage device.

 Previous information saved on the USB storage device will be deleted.

Date & Time

You can set the system date and time automatically or manually. You can also set the time display mode.

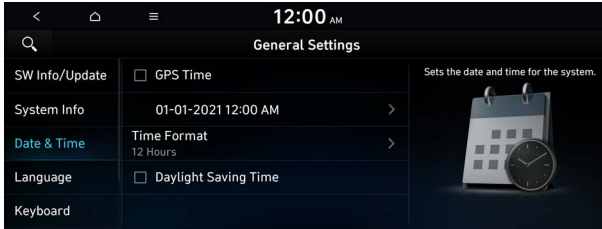

GPS Time

After receiving the time from GPS, it sets the system date and time automatically.

 To manually set the date and time, uncheck **GPS Time**, press the current date and time below **GPS Time**, and then set the date and time.

Time Format

Change the system time display format.

Daylight Saving Time

Displays the system time in the format of Daylight Saving Time.

Language

You can set the system display language.



- Once the language has been changed, it takes a while to apply the new language to the system. The notification pop-up window appears as soon as the new language is applied to the system. When you wait a while or press anywhere outside the pop-up window, the window automatically disappears.
- When you change the system language, it does not affect the display of other unique data such as MP3 music file name.
- Depending on the system language, the Bluetooth phone message view and voice recognition may not be supported.

Keyboard

You can change the keyboard type for each language to use when entering the text.



English-Latin Keyboard Type

You can select the keyboard type to use when entering the English text.

Default Keyboard

You can select the default keyboard type.

Units (if equipped)

You can specify the units to display on the system screen.

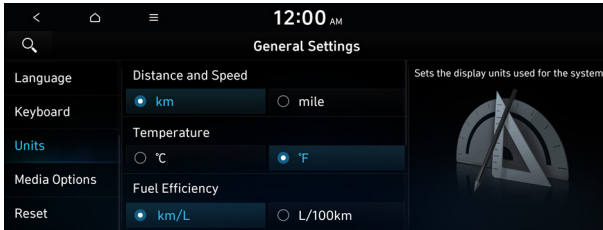

Distance and Speed

You can select the units for distance and vehicle speed to display on the screen.

Temperature

You can select the temperature unit to display on the screen.

Fuel Efficiency or Energy Economy

You can select the unit for fuel (energy) economy to display on the screen.

 The displayed name may differ depending on the vehicle model and specifications.

Tire Pressure

You can select the unit for tire pressure to display on the screen.

Torque (if equipped)

You can select a torque unit to display on the system screen.

Turbo Boost (if equipped)

You can select a turbo boost unit to display on the system screen.

Media Options (if equipped)

You can set the media player not to start automatically when starting the engine or set it to notify you of any information changes during media playback.

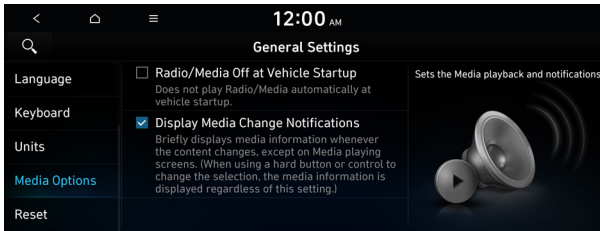

 The screen may differ depending on the vehicle model and specifications.

Radio/Media Off at Vehicle Startup

You can set the media player not to start automatically when starting the engine.

Display Media Change Notifications (if equipped)

You can set the system to briefly display media information at the top of the screen if the current song or channel changes when not on the main media screen.

Reset

You can reset your system settings to the default values.

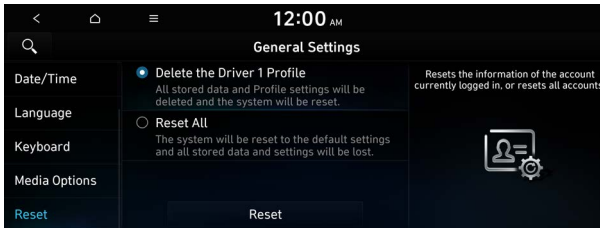

 You can also initialize all settings of the login profile.

Caution

- When initialization is performed, all user data in the system including the location data is deleted.
- When phone projection is active, you cannot reset the system settings. To reset the settings, remove the USB cable from your system.

Configuring the screen layout settings (Type2) (if equipped)

You can configure the settings for the display and themes.

✎ Available settings may differ depending on the vehicle model and specifications.

1 On the All Menus screen, press **Setup ► Screen Layout**.

The screen layout settings screen appears.

2 Configure the settings required:

✎ Press **☰ ► Search for Settings** or press **🔍** and enter a keyword to search for a setting item. You can also search for a setting item by voice.

✎ If you press **Display Off** at the top of the screen, the screen is switched off. To switch the screen back on, press the screen or briefly press the power button.

Graphic Themes (if equipped)

Select the desired display theme.

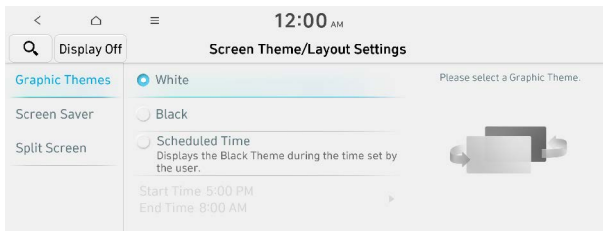

Screen Saver

You can select the items to display on the screen saver in standby mode.

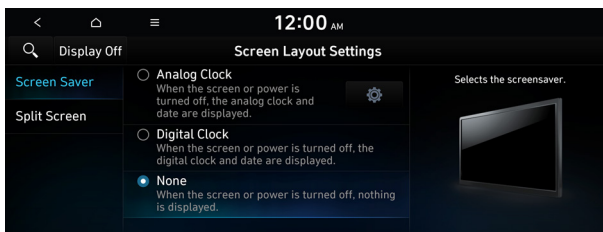

Analog Clock

Displays the analog clock on the system screen saver.

✎ Press  to choose the Analog Clock to show on the screen.

Digital Clock

Displays the digital clock on the system screen saver.

None

Displays nothing on the system screen saver.

Split Screen

You can specify the items to display on the Split Screen.

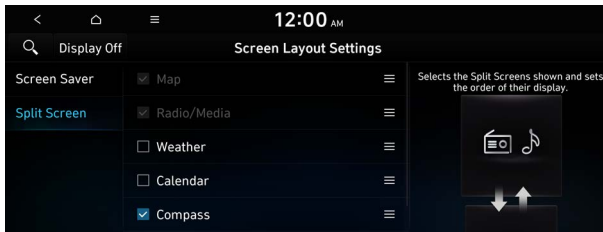

✎ The screen may differ depending on the vehicle model and specifications.

✎ This option is only available when the display supports Split Screen.

✎ On the screen list, press  on the right and drag the item to reposition.

Configuring the display settings (Type1)

You can change the system display settings such as display brightness.

1 On the All Menus screen, press **Setup ► Display**.

The display settings screen appears.

2 Configure the settings required:

✎ Press **Menu ► Search for Settings** or press  and enter a keyword to search for a setting item. You can also search for a setting item by voice.

✎ If you press **Display Off** at the top of the screen, the screen is switched off. To switch the screen back on, press the screen or briefly press the power button.

Illumination

You can set the system to automatically adjust the display brightness depending on the ambient light intensity. You can also set the system to keep the display bright or dark all the time. You can set the system to automatically adjust the display brightness depending on the cluster illumination. You can also set the level of display brightness to use while using the daytime or night mode.

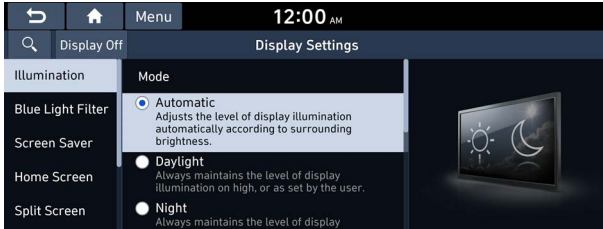

Mode

- **Automatic:** The display brightness is automatically adjusted based on the surrounding environment.
- **Daylight:** It keeps the display always bright regardless of the surrounding environment.
- **Night:** It keeps the display always dark regardless of the surrounding environment.

Illumination

- **Link to Cluster Illumination Control:** The display brightness is automatically adjusted based on the cluster illumination.
- **Daylight:** You can set the display brightness when **Daylight** is selected under **Mode**. Uncheck **Link to Cluster Illumination Control** and then set to the desired brightness.
- **Night:** You can set the display brightness when **Night** is selected under **Mode**. Uncheck **Link to Cluster Illumination Control** and then set to the desired brightness.

 To reset all screen brightness settings to the default values, press **Reset**.

Blue Light Filter

Enable blue light filtering to adjust the screen light to reduce the level of eye strain.

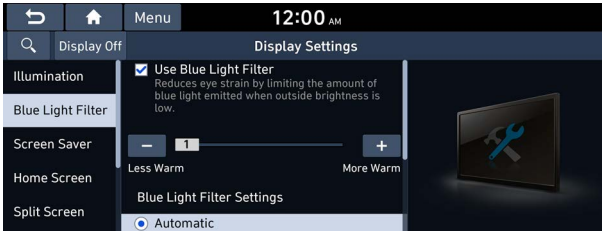

Use Blue Light Filter

Enable or disable blue light filtering.

Blue Light Filter Settings

Set to activate blue light filtering automatically based on the ambient light or pick the time range manually.

- **Automatic:** Enable blue light filtering based on the ambient light.
- **Scheduled Time:** Enable blue light filtering during the set time range.

Screen Saver

You can select the items to display on the screen saver in standby mode.

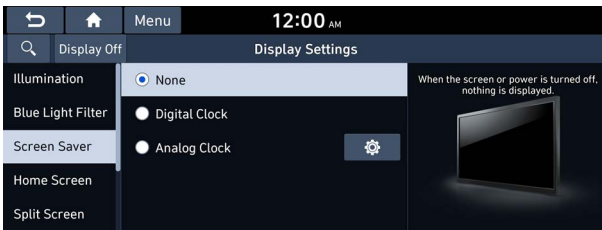

 The screen may differ depending on the vehicle model and specifications.

None

Displays nothing on the system screen saver.

Digital Clock

Displays the digital clock on the system screen saver.

Analog Clock

Displays the analog clock on the system screen saver.

✎ Press  to choose the Analog Clock to show on the screen.

Home Screen

You can change the layout of the Home screen.

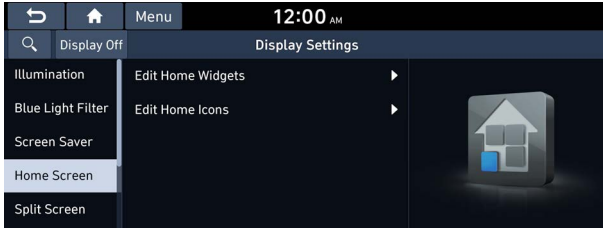

✎ The screen may differ depending on the vehicle model and specifications.

Edit Home Widgets

You can edit the types and arrangement of home widgets.

✎ For more information: ► see "Editing widgets on the Home screen (Type1)."

Edit Home Icons

You can edit the arrangement of home icons.

✎ For more information: ► see "Editing icons on the Home screen (Type1)."

Split Screen

You can specify the items to display on the Split Screen.

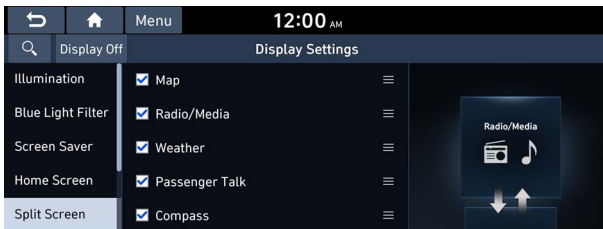

✎ The screen may differ depending on the vehicle model and specifications.

✎ This option is only available when the display supports Split Screen.

✎ On the screen list, press  on the right and drag the item to reposition.

Media Change Notifications

You can set to briefly display media information at the top of screen while playing the next item when you move from the media player screen to another.

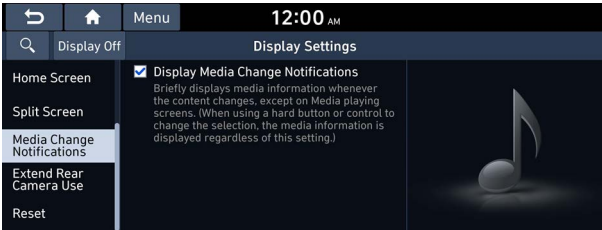

Extend Rear Camera Use

You can set to display the rear camera display even when you change the shift position other than "R" (Reverse) after reversing.

✍ When you shift to "P" (Park) or drive at a predetermined speed or faster, the rear view display disappears to display the previous screen.

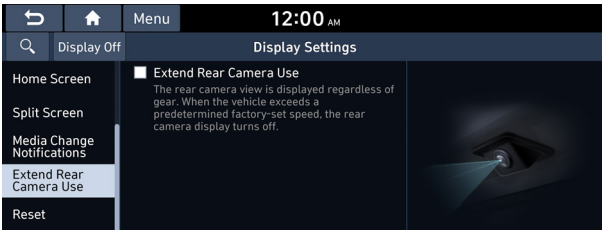

Reset

You can initialize all display settings such as brightness.

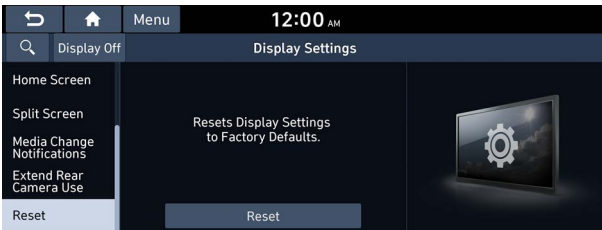

Configuring the display settings (Type2)

You can change the system display settings such as display brightness.

1 On the All Menu screen, press **Setup ► Display**.

The display settings screen appears.

2 Configure the settings required:

- ✎ Press **☰ ► Search for Settings** or press **🔍** and enter a keyword to search for a setting item. You can also search for a setting item by voice.
- ✎ If you press **Display Off** at the top of the screen, the screen is switched off. To switch the screen back on, press the screen or briefly press the power button.

Illumination

You can set the system brightness to be adjusted according to the ambient lighting conditions or set the screen to stay bright or dimmed. You can also set to automatically adjust the display brightness depending on the cluster illumination.

- ✎ To reset all screen brightness settings to the default values, press **Reset**.



Option A

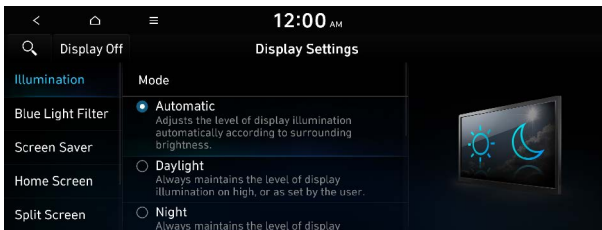

Option B

- ✎ The screen may differ depending on the vehicle model and specifications.

Auto-adjust Brightness (if equipped)

You can set the system brightness to be adjusted according to the ambient lighting conditions. Press  to set the brightness for the day or night mode.

Adjust Manually (if equipped)

You can set the screen to stay bright or dimmed.

Mode (if equipped)

- **Automatic:** The display brightness is automatically adjusted based on the surrounding environment.
- **Daylight:** The display brightness is adjusted to ensure that items are easier to see when the surrounding area is bright.
- **Night:** The brightness is adjusted to prevent glare when the surrounding area is dark.

Illumination (if equipped)

- **Link to Cluster Illumination Control:** The display brightness is automatically adjusted based on the cluster illumination.
- **Daylight:** You can set the display brightness when **Daylight** is selected under **Mode**. Uncheck **Link to Cluster Illumination Control** and then set to the desired brightness.
- **Night:** You can set the display brightness when **Night** is selected under **Mode**. Uncheck **Link to Cluster Illumination Control** and then set to the desired brightness.

 To reset all screen brightness settings to the default values, press **Reset**.

Blue Light Filter

Enable blue light filtering to adjust the screen light to reduce the level of eye strain.



Use Blue Light Filter

Enable or disable blue light filtering.

Blue Light Filter Settings

Set to activate blue light filtering automatically based on the ambient light or pick the time range manually.

- **Automatic:** Enable blue light filtering based on the ambient light.
- **Scheduled Time:** Enable blue light filtering during the set time range.

Extend Rear Camera Use (if equipped)

You can set to display the rear camera display even when you change the shift position other than "R" (Reverse) after reversing.

🔗 When you shift to "P" (Park) or drive at a predetermined speed or faster, the rear view screen disappears to display the previous screen.



Audio System ON/OFF (if equipped)

You can set so that power for the system is maintained when the vehicle is turned off.



Camera Settings (if equipped)

You can adjust the brightness and contrast for driving assist views.

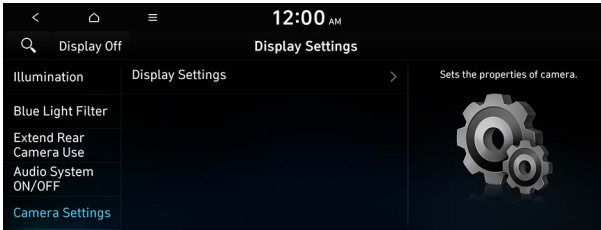

Screen Saver (if equipped)

You can select the items to display on the screen saver in standby mode.

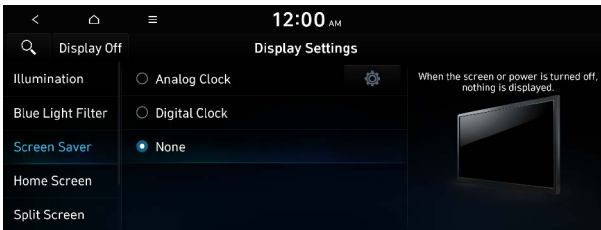

Analog Clock

Displays the analog clock on the system screen saver.

✎ Press  to choose the Analog Clock to show on the screen.

Digital Clock

Displays the digital clock on the system screen saver.

None

Displays nothing on the system screen saver.

Home Screen (if equipped)

You can rearrange the icons displayed on the All screen.

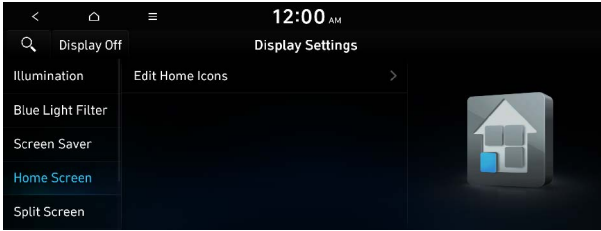

Edit Home Icons

You can edit the arrangement of home icons.

 For more information: ► see "Editing the icons on the Home screen (Type2)."

Split Screen (if equipped)

You can specify the items to display on the Split Screen.



 The screen may differ depending on the vehicle model and specifications.

 This option is only available when the display supports Split Screen.

 On the screen list, press  on the right and drag the item to reposition.

Media Change Notifications (if equipped)

You can set to briefly display media information at the top of screen while playing the next item when you move from the media player screen to another.



Configuring the media settings (Type1)

(if equipped)

Set to receive a notification when the information changes during playback or to include sub-folders when playing a folder on repeat.

1 On the All Menus screen, press **Setup ► Media**.

The media settings screen appears.

2 Configure the settings required:

Media Change Notifications

You can set to briefly display media information at the top of screen while playing the next item when you move from the media player screen to another.

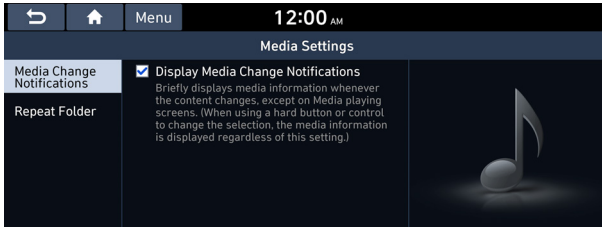

Repeat Folder

You can set to include sub-folders when playing a folder on repeat.

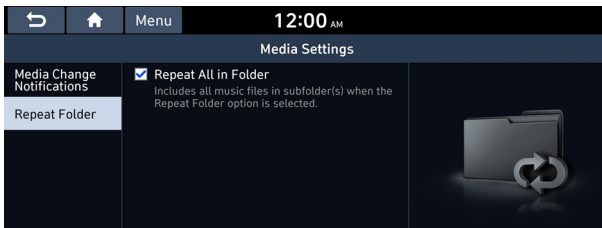

How to Update the Map and Software for your Infotainment System

To ensure you are maximizing the full potential of your navigation system, we advise updating the map and software annually. To update, visit the map update website and install the Navigation Updater program onto your PC. Use the program to download and install the latest map, points of interest, and software. Alternatively, you can visit your local dealership to update.



Caution

- It may take a while (tens of minutes) to finish the system update depending on the amount of data.
- Never turn off the system or remove the storage before finishing the system update. When the system is turned off or the storage device is removed from the system while updating, it may cause data or system damage.
- ✍ After update is completed, the system automatically restarts and the SW Info/Update screen displays the updated version.
- ✍ During update, you cannot use the navigation system, Bluelink service, camera, and infotainment system.
- ✍ For assistance concerning the update, contact the Customer Center at 888-216-2626.
- ✍ Changes are not applied to the map after creation of all update files. For this reason, road names, POI names, speed limits, or other map information displayed, may not be the latest values due to the creation time of the update files.

Updating via a USB device

Install the Navigation Updater on your PC and then download the latest data to a USB device for update to the navigation map and infotainment system.

Installing Navigation Updater

On your PC, visit the website at <http://update.hyundai.com/ca> to download and install the Navigation Updater software.

- ✍ For system requirements for installing the program and details on how to install it, visit the website.

Updating the software and map

- 1 Connect a USB device to the computer and run Navigation Updater for downloading the update files.
- 2 Follow the instructions on the screen to download the update files.
- 3 Remove the USB device from the computer and then connect it to the USB port in your vehicle.
- 4 Start the vehicle to turn on the system.

 You can perform update without starting the vehicle by simply locating the start switch to "ON".



Caution

- Perform update with the start switch "ON" when the battery is sufficiently charged by driving the vehicle. When the battery is discharged while updating, the system may get damaged with the update stopped.
 - Note that the battery may be discharged easily in winter.
 - The battery may also be discharged easily when the vehicle is not used for a long time. Caution is required.
- When you start the vehicle while updating with the start switch "ON", power supply to the system may be cut off.

- 5 On the All Menu screen, press **Setup ► General ► SW Info/Update**.

 After the system is turned on, press **Yes** when a pop-up window appears whether to proceed with update. In this case, the screen changes to allow you to select the update method.

Updating immediately

You can finish the update quickly.

- 1 On the **SW Info/Update** screen, press **Update**.
- 2 Press **Update Now**.
- 3 Press **OK**.

The update is performed immediately after the system reboots.

Background Update

You can perform update while using the system.

- 1 On the **SW Info/Update** screen, press **Update**.
- 2 Press **Background Update**.
- 3 Press **OK**.

✍ Compared to Update Now, it may take longer.

✍ On the All Menus screen, press **Setup ► General ► SW Info/Update** to see the update progress.

✍ It is possible to start background updates only when the vehicle is on.

✍ It is possible to continue to perform updates even after turning off the vehicle while updates are in progress. On the notification window displayed when the vehicle is turned off, press **Update** to perform the remaining updates to complete the process successfully. For later update, press **Later**.

✍ If the update process is not completed, a notification window appears asking if you want to perform updates each time you turn off the vehicle.

✍ All system functions, including the rear view camera, are disabled while updates are in progress.

Scheduling an update

When you set for scheduled update after downloading the latest data, the navigation map and infotainment system can be updated while not using the vehicle.

- 1 On the **SW Info/Update** screen, press **Update**.
- 2 Press **Install after Turning Off the Ignition**.
- 3 Set the update time and press **OK**.

When scheduling the update is finished, the status indicator icon appears.

✍ You can set to start the update within 12 hours or less after the vehicle is stopped.

- 4 Turn off the vehicle (ACC Off).

- ✎ Make sure that a USB device with update files is connected to the system before turning off the vehicle.
- ✎ When you set the update time to "0", the update notification window appears and then the update starts.
 - To close the notification window and proceed with the update, press **Yes**.
 - To cancel the update, press **No**.
- ✎ Once the update has started, you cannot cancel it. After the update, the system automatically turns off.
- ✎ When you start the vehicle, the update complete notification appears to show the update result. After update is completed, the SW Info/Update screen displays the updated version.
- ✎ When you turn on the system while updating, you can see its progress.
- ✎ Scheduled update is canceled when:
 - Low battery is detected when turning off the vehicle.
 - The storage device with the update files is disconnected.
 - The vehicle is started before the update scheduled time.
 - The system has been turned off for more than 3 minutes with the vehicle turned off.

MEMO

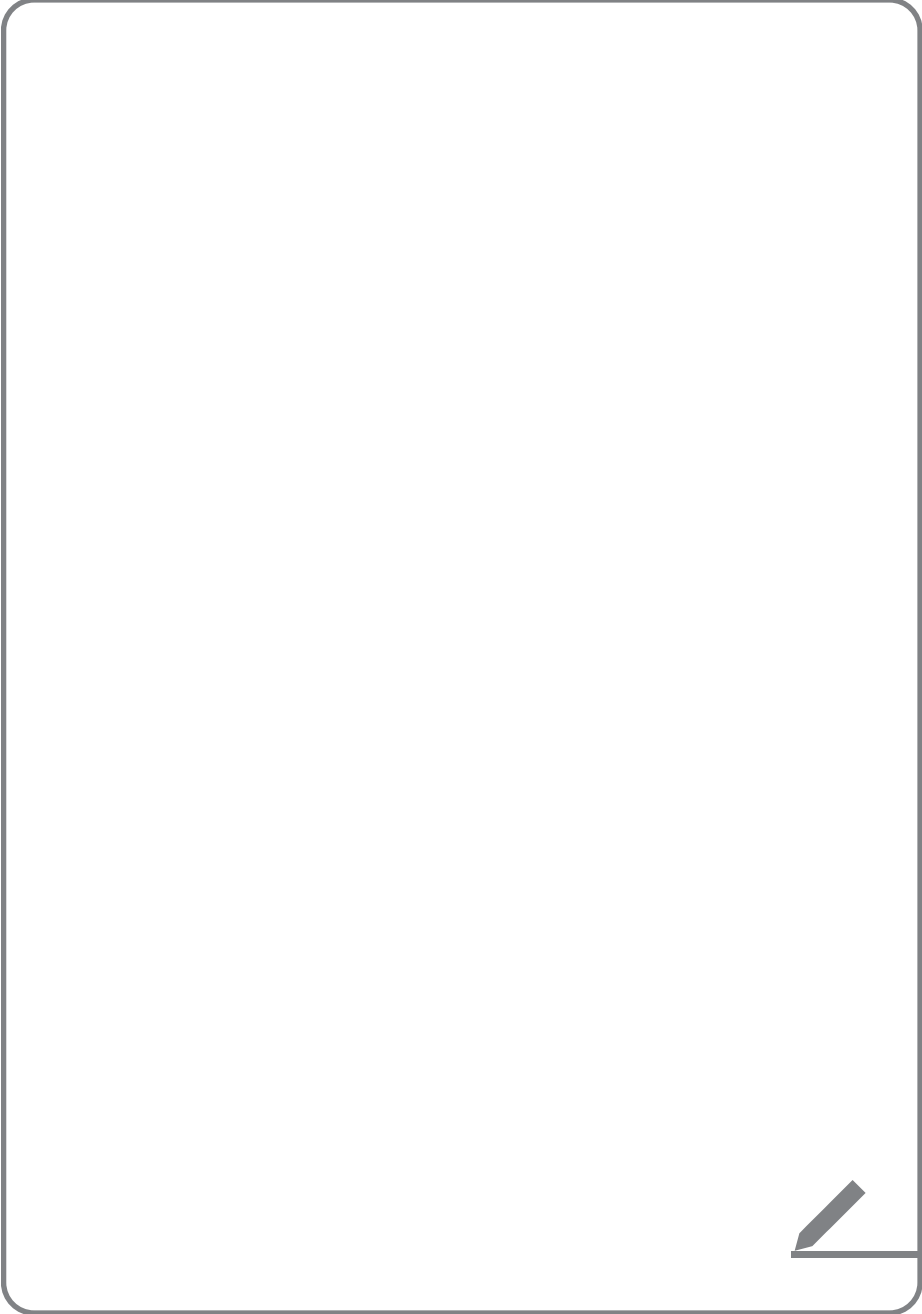

10

Appendix

Solutions

System status indicator icons

FAQ

Product specifications

Important information

Index

Trademarks

Open Source Information



Solutions

Before reporting a malfunctioning system, refer to the following table and see if you can identify and fix the problem. If the problem persists or you are unable to locate your specific need, contact your place of purchase or dealer.

Sound and display

Symptom	Possible cause	Solution
A blank screen appears and sound is not audible.	The system is turned off.	<ul style="list-style-type: none">• Check that the start switch is in "ACC" or "ON."• Press the Power button on the control panel to turn on the system.
	Sound volume is too low.	Use the Volume knob/button on the control panel to adjust the volume.
	Sound is muted.	Press the Mute button on the steering wheel to unmute.
Sound is audible from only one side of the speakers.	Sound is imbalanced.	On the All Menus screen, navigate to Setup ► Sound and use the settings menu to adjust the sound balance.
The sound is cut off or noise is heard.	Vibration occurs in the system.	When the system vibrates, the sound may be cut off or noise may occur. This is not a system failure. The system is restored as soon as the vibration stops.

Symptom	Possible cause	Solution
The image quality is poor.	Screen adjustment is required.	On the All Menus screen, navigate to Setup ► Display and use the settings menu to adjust the display settings.
	Vibration occurs in the system.	The images may get distorted when vibration occurs in the system. This is not a system failure. The system is restored as soon as the vibration stops.
	The display is aged or the system performance is degraded.	If the problem persists, contact your place of purchase or dealer.
Small red, blue, and green dots are shown on the screen.		LCD has very high-density pixels. For this reason, there may be dead pixels (that are always off) or lit pixels (that are always on) within 0.01 percent of the total pixels.

USB playback

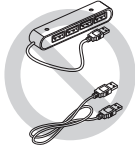
Symptom	Possible cause	Solution
Files in a USB device cannot be played.	There are no compatible files for playback	Copy the files that can be played by the system to the USB device and connect the device again. ► See "USB mode."
	Poor connection is found.	Remove the USB device from the USB port and then reconnect it properly.
	The USB device is dirty.	Remove foreign materials from the surface that contacts the USB device and USB port.
	A USB hub or extension cable is used.	Connect the USB device directly to the USB port on the vehicle.
		
The USB device is non-standard.	Use a USB device that is compatible with the system. ► See "USB mode."	
The USB device is damaged.	Use your computer to format the USB device and then connect the device again. Format the device in FAT16/32 format.	

Bluetooth connection

Symptom	Possible cause	Solution
The system is not detected by a Bluetooth device.	Registration mode needs to be run.	On the All Menus screen, navigate to Setup ► Device Connections , run the device registration mode and then perform search again from the device. ► See " Connecting a Bluetooth device. "
The Bluetooth device is not connected.	The Bluetooth function should be activated. Any error occurs while using the Bluetooth function.	Activate the Bluetooth function on the Bluetooth device to connect. <ul style="list-style-type: none">• Turn the Bluetooth function OFF / ON on the Bluetooth device and then connect the device again.• Turn the Bluetooth device off and on and then connect the device again.• Remove the battery from the Bluetooth device and attach it back, turn on the device, and then connect the device again.• Delete the system and Bluetooth device from the registration lists respectively, and then connect the device again.

Phone projection

Symptom	Possible cause	Solution
The phone projection function is not performed when a smartphone is connected using a USB cable.	Phone projection is not supported.	Visit the website to check whether your smartphone supports the phone projection. <ul style="list-style-type: none">• Android Auto: https://support.google.com/androidauto• Apple CarPlay: http://www.apple.com/ios/carplay
	The function is inactive.	<ul style="list-style-type: none">• On the All Menus screen, navigate to Setup ► Device Connections and activate the connection function from the Phone Projection Settings menu.• Make sure that the phone projection is not disabled in the App settings or block-out settings on your smartphone.
	Smartphone is encountered with poor operation or malfunction.	<ul style="list-style-type: none">• Check that the smartphone battery level is not too low. Recognition may not work properly when the battery level is too low.• The phone projection may not work properly when the signal strength is weak.• When the smartphone is locked, first unlock it.• Initialize the smartphone and connect the device again.
A black screen appears when the phone projection is activated or in use.	The smartphone malfunctions.	<ul style="list-style-type: none">• Remove the USB cable from the smartphone and connect the device again.• Initialize the smartphone and connect the device again.

System operation

Symptom	Possible cause	Solution
The previous media mode does not appear when the system is turned off and on.	It is encountered with poor media connection or playback error.	When the media source is not connected or played normally, the previous mode appears. Connect the media source again or play it again.
The system slows down or does not operate at all.	An internal error occurs in the system.	<ul style="list-style-type: none">Restart the system by pressing the reset button with a sharp object such as pen or clip.If the problem persists, contact your place of purchase or dealer.
The system is not turned on.	Fuse-related issues	<ul style="list-style-type: none">Visit an auto service shop and replace the fuse with a new one of appropriate capacity.If the problem persists, contact your place of purchase or dealer.

Navigation system operation

Symptom	Possible cause	Solution
The destination is not searched.	Outdated map data	Update the map to the latest version. ► See "How to Update the Map and Software for your Infotainment System."
Route guidance of the navigation system does not match the actual road conditions.	Outdated map data	Update the map to the latest version. ► See "How to Update the Map and Software for your Infotainment System."
	There have been changes in the road after a map update.	Route guidance of the navigation system may not match the actual road conditions even after the map is updated to the latest version because the update depends on the creation date. Be sure to drive according to actual road conditions and regulations.
Guidance is made by bypassing the route or the speed camera alerts are not followed.	The update for the system and map data is required.	Update the map to the latest version. ► See "How to Update the Map and Software for your Infotainment System."
The real-time traffic information is not received.	Poor signal reception	<ul style="list-style-type: none">• Reception of traffic information may not be made smoothly in mountain and island areas. Check the reception status again in a region with strong signals.• If the problem persists, contact your place of purchase or dealer.

System status indicator icons

You can see the system status by checking the status indicator icons at the top right of the system screen.

Different status indicator icons appear when each function is performed. The meanings of the icons are as follows:

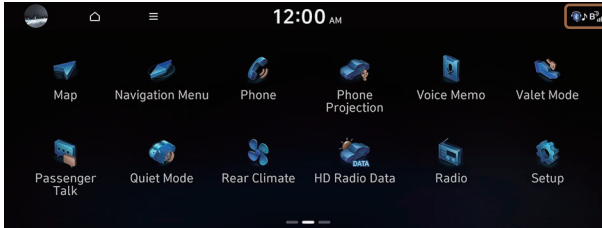

Mute/memo recording



	Navigation sound muted
	Radio/Media sound muted
	All sound outputs muted
	Recording a voice memo

Bluetooth/call



	Connecting a phone via Bluetooth
	Connecting an audio device via Bluetooth
	Connecting a phone and an audio device via Bluetooth
	Making a call via a Bluetooth phone
	Bluetooth phone's microphone off
	Downloading the contact and list of recent calls from the connected Bluetooth phone

Bluelink



	Talking with a Bluelink phone
	Bluelink phone's microphone off
	Bluelink network's signal strength

System update



	Scheduling the update
	Updating

Available functions in the rear seat (if equipped)



	Rear-seat remote control locked
	Rear-seat sleep mode On
	Front-seat driver is having a conversation with a rear-seat occupant

Wireless charging



	Wireless charging in progress
	Wireless charging complete
	Wireless charging failure

Some icons may not appear depending on the vehicle model and specifications.

FAQ

Navigation

Q How can I update the map?

A You can download the latest map data to a USB device and use the device to update the map. ▶ See "How to Update the Map and Software for your Infotainment System."

Q Guidance is made by bypassing the route or the speed camera alerts are late.

A Select another route after setting the route options. On the map screen, press  ▶ **Route** ▶ **Route Options** to change the settings and resume navigation.
▶ See "Changing the route search option."

When the system is not updated, update the software and map and then perform search again. ▶ See "How to Update the Map and Software for your Infotainment System."

Bluetooth

Q Which functions can I use via Bluetooth?

A You can use the hands-free call function with a mobile phone connected. You can also play music after connecting an audio device such as MP3 player or mobile phone. ▶ See "Making a call via Bluetooth," "Playing music via Bluetooth."

Q How can I register a Bluetooth device?

A On the All Menus screen, press **Setup** ▶ **Device Connections** ▶ **Device Connections** ▶ **Add New**. From the Bluetooth device to be connected, search for the vehicle system and register it. Use the Bluetooth device to enter or approve the authentication number displayed on the system. Then the device is added to the list of Bluetooth devices in the system and automatically connected to the system.
▶ See "Connecting a Bluetooth device."

Q I bought a new mobile phone and want to replace my old phone with the new one to connect the system. How can I register the new phone to the system?

A An additional device can be registered in the same way as in registration of a new device. You can register up to 6 devices in the list of Bluetooth devices. To delete a previously registered device, press **Delete Device(s)** from the list of Bluetooth devices, select the device to delete, and then press **Delete**. ▶ See "Deleting a registered device."

Q How can I access the list of contacts while using a Bluetooth phone?

A Approve access to the contacts when connecting your mobile phone to the system via Bluetooth. The list of contacts on the phone is downloaded to the system. To see the downloaded list of contacts, press the Call button on the steering wheel and press  on the call screen. You can search for a contact and make a call to the contact, or add the contact to the favorites. ▶ See "Dialing from the contacts."

Broadcast reception

Q I turned on the radio while driving but I heard no sound but noise.

A Depending on the location, obstacles may cause reception to deteriorate. Radio reception rate may also drop when an on-glass antenna is mounted on the rear window and the window is tinted with metallic window films.

Self-inspection method upon failure

Q The system does not operate properly. What shall I do?

A Inspect the system after referring to Troubleshooting Guide. ▶ See "Solutions."
When the system failure persists after inspection, press and hold the Reset button to reset the system.
If the problem persists, contact your place of purchase or dealer.

Product specifications

Media player

USB mode

Music files

Item	Specifications
File format	MPEG-1/2 Layer3, OGG (Vorbis), FLAC, WMA (Standard/Professional), WAV
Bit-rate and sampling frequency	MP3 8–320 kbps (CBR/VBR), up to 48 kHz (ID3 tag version: Ver. 1.0, Ver. 1.1, Ver. 2.2, Ver. 2.3, Ver. 2.4)
	OGG Q1 to Q10, up to 48 kHz
	FLAC 8/16/24-bit, up to 48 kHz
	WMA Standard (0x161): up to L3 Profile, up to 385 kbps, up to 48 kHz Professional (0x162): up to M0b, up to 192 kbps, up to 48 kHz
	WAV 8/16 to bit, up to 48 kHz
Specification details	Max. number of directory layers: 20 layers Max. folder/file name length: 255 Bytes Valid characters that can be used in a folder/file name: 2,350 Alphanumeric characters/4,888 Chinese characters Max. number of folders: 2,000 (including the root) Max. number of files: 8,000

- ✎ The following files are not played.
 - Modified files (format-changed files)
 - Variant files (e.g. MP3 files encoded by WMA audio codec)
 - DRM (Digital Rights Management)-protected files
 - Files with no index
- ✎ Sound quality is not guaranteed in case of music files that use the bit-rate exceeding 192 kbps.
- ✎ With the files that do not use the fixed bit rate, some functions may not work properly or the playback time may not appear accurately.
- ✎ When a trouble occurs while playing or you want to play an incompatible format file, use the latest encoder software to change the format before using the file.

■ USB storage devices

Item	Specifications
Byte/Sector	64 KB or less
Format system	FAT16/32 (recommended), exFAT, NTFS

- ✎ With the USB storage devices that are not equipped with a plug-type connector (metal cover type), proper operation is not guaranteed.
 - USB storage devices with a plastic plug may not be recognized.
 - USB memory cards (e.g. CF cards, SD cards) may not be recognized.
- ✎ Problems that are caused by using USB storage devices (not specified in the following list), are not covered by the warranty.

Product name	Manufacturer
XTICK	LG
BMK	BMK Technology
SKY-DRV	Sky Digital
TRANSCEND JetFlash	TranScend
Sandisk Cruzer	SanDisk
Micro ZyRUS	ZyRUS
NEXTIK	DIGI Works

- ✎ USB hard drives may not be recognized.
- ✎ When using a USB mass storage device divided into logical drives, only the files saved in the first drive can be played.
- ✎ When a USB storage device has some Apps, media files may not be played.

Common specifications

Item	Specifications
Power supply	DC 14.4 V
Operating voltage	DC 9-16 V
Dark current	Below 1 mA in average within 45 days
Operating temperature range	-20 to +70 °C
Storage temperature range	-40 to +85 °C
Electric current consumption	2.5 A

Radio

Item	Specifications
Available channels	FM: 87.5–107.9 MHz (step: 200 kHz) AM: 530–1710 kHz (step: 10 kHz)
Sensitivity	FM: Within 10 dBuV AM: Within 35 dBuV EMF
Distortion factor	Within 2 %

Bluetooth

Item	Specifications
Frequency range	2400–2483.5 MHz
Supported Bluetooth version	4.1/4.2
Supported profiles	Hands-free (1.7), A2DP (1.3), AVRCP (1.6), PBAP (1.1/1.2), MAP (1.2/1.4)
Bluetooth Power Class 2	-6 to 4 dBm
Antenna power output	2.5 mW (max.)
Number of channels	79

LTE RF

Item	Specifications
LTE	Reception Frequency: 1930 MHz to 1990 MHz (B2), 2110 MHz to 2155 MHz (B4), 869 MHz to 894 MHz (B5), 2620 MHz to 2690 MHz (B7), 729 MHz to 746 MHz (B12) Sensitivity: -94.3 dBm under@10 M (B2, 5, 7), -96.3 dBm under@10 M (B4), -93.3 dBm under@10 M (B12) (Throughput \geq 95 %)
	Transmission Frequency: 1850 MHz to 1910 MHz (B2), 1710 MHz to 1755 MHz (B4), 824 MHz to 849 MHz (B5), 2500 MHz to 2570 MHz (B7), 699 MHz to 716 MHz (B17) Maximum RF output power: Power Class 3 (B2, B4, B5, B12), 20.3 dBm to 25.7 dBm (conducted)
WCDMA	Reception Frequency: 1930 MHz to 1990 MHz (B2), 869 MHz to 894 MHz (B5) Sensitivity: -104.0 dBm under (BER = 0.1 % under)
	Transmission Frequency: 824 MHz to 849 MHz (B5), 1850 MHz to 1910 MHz (B2) Maximum RF output power: 20.3 dBm to 25.7 dBm (Power Class3, conducted)

Important information

Before using your system, read and follow all instructions and safety information provided in this user's guide ("User's Manual"). Not following precautions found in this guide can lead to an accident or other serious consequences.

Keep this guide in your vehicle

When kept in the vehicle, this guide will be a ready reference for you and other users unfamiliar with the system. Ensure that before using the system for the first time, all persons have access to this guide and read its instructions and safety information carefully.

Warning

Operating certain parts of this system while driving can distract your attention away from the road, and possibly cause an accident or other serious consequences. Do not change system settings or enter data non-verbally (using your hands) while driving. Stop the vehicle in a safe and legal manner before attempting these operations. This is important since while setting up or changing some functions as you may to distract your attention away from the road and remove your hands from the steering wheel.

General operation

Voice command control

Features within the system may be executed using only voice commands. Using voice commands while driving allows you to operate the system without removing your hands from the steering wheel.

Prolonged views of screen

Do not access any function requiring a prolonged view of the screen while you are driving. Pull over in a safe and legal manner before attempting to access a function of the system requiring prolonged attention. Even short views of the screen may be hazardous if your attention has been diverted away from your driving.

Volume setting

Do not raise the volume excessively. Keep the volume at a level where you can still hear outside traffic and emergency signals while driving. Driving while unable to hear these sounds could cause an accident.

Navigation features

Navigation features included in the system are intended to provide detailed instructions to get you to a desired destination. Ensure that all persons using this system carefully read and follow all instructions on safety information.

Distraction hazard

Some navigation features may require manual (non-verbal) setup. Attempting to perform such setup or inputting data while driving can seriously distract your attention and could cause an accident. Stop the vehicle in a safe and legal manner before attempting these operations.

Let your judgment prevail

Any navigation features are provided only as an aid. Make your driving decisions based on your observations of local conditions and existing traffic regulations. Any such feature is not a substitute for your personal judgment. Any route suggestions made by this system should never replace any local traffic regulations or your personal judgment or knowledge of safe driving practices.

Route safety

Do not follow the route suggestions if doing so would result in an unsafe or illegal maneuver, if you would be placed in an unsafe situation, or if you would be directed into an area that you consider unsafe. The driver is ultimately responsible for the safe operation of the vehicle and must evaluate whether it is safe to follow the suggested directions.

Potential map inaccuracy

Maps used by this system may be inaccurate because of changes in roads, traffic controls or driving conditions. Always use good judgment and common sense when following the suggested routes.

Emergency services

Do not rely on any navigation features included in the system to direct you to emergency services. Ask local authorities or an emergency services operator for these locations. Not all emergency services such as police, fire stations, hospitals and clinics are contained in the map database for navigation features.

Use of speech recognition functions

Speech recognition software is inherently a statistical process which is subject to errors. It is your responsibility to monitor any speech recognition functions included in the system and address any errors.

Index

A

Advanced system settings 9-49

Android devices

Android Auto 2-5

Apple devices

Apple CarPlay 2-7

B

Battery warning 1-7

Bluelink

Bluelink menu

Diagnosing the vehicle 8-9

Maintenance service intervals 8-9

Roadside Assistance 8-11

Schedule details 8-5

Settings 8-10, 9-81, 9-82

Voice Local Search 8-10

Weather information 8-8

Bluelink service 8-2

Route guidance service 8-12

Safety and security services 8-11

Auto Collision Notification 8-11

SOS 8-12

Bluetooth

Bluetooth phone

Answering a call 6-15

Call 6-6

Contacts list 6-10

Dial pad 6-12

Favorites settings 6-8

Options during a call 6-16

Recent calls list 6-6

Switching to another call 6-17

Text message 6-17

Specifications 10-15

Bluetooth connection

Adding a device 6-2

Deleting a device 6-5

Device connection 6-4

Disconnecting a device 6-5

C

Climate

Climate settings 9-11, 9-33

Climate control function 2-14

Component names and functions

Control panel

Custom button 1-3

MAP button 1-2

MEDIA button 1-3

NAV button 1-2

POWER button/VOLUME knob 1-2

RADIO button 1-3

Search lever/knob 1-3

SEEK/TRACK button 1-3

SETUP button 1-3

System Reset button 1-3

VOLUME button 1-2

Steering wheel remote control

Call button 1-4, 1-5

Custom button 1-5

End Call button 1-4, 1-5

MODE button 1-4

Move lever/button 1-4

Voice Recognition button 1-4

Volume lever/Mute button 1-4

Contacts list 6-11

Control panel 1-2

D

- Defog/Defrost Options 9-12, 9-34
- Deleting a location 5-26
- Destination search 5-3
- Driving assistance screen 2-9
- Driving Information 2-26

E

- Editing a route 5-16
- EV charging stations 5-29

F

- FAQ
 - Bluetooth 10-11
 - Broadcast reception 10-12
 - Navigation 10-11
 - Self-inspection method upon failure 10-12
- Finding a route easily
 - Destination search 5-3
- Finding the route
 - Adding a waypoint 5-17
 - Address search 5-10
 - Frequently visited places 5-24
 - Gas stations 5-28
 - Location registration
 - Deleting a POI 5-26
 - Editing a POI 5-25
 - Registration after search 5-22

- Map 5-6
- Map update 9-110
- Previous Destinations 5-12
- Saving the current position 5-23
- Searching for POIs 5-14
- Volume adjustment 5-9

H

- HD Radio Data 2-23
- HD Radio™ 3-11
- Home screen 1-11

L

- Listening to music
 - Bluetooth audio 4-8
 - USB music 4-2
- Location registration 5-22

M

- Map 5-6
- Map update 9-110
- Media device connection 4-2
- Media player
 - Bluetooth audio 4-8
 - USB music 4-2
- Messages 6-17

N

- Navigation 5-2, 5-10
- Navigation settings 9-69, 9-74
- N mode 2-29
- Notifications 2-27

P

Parking assist guide lines 2-9

Phone projection

Android Auto 2-5

Apple CarPlay 2-7

Previous Destinations 5-12

Product specifications

Bluetooth 10-15

Common specifications 10-15

LTE RF 10-16

Media player 10-13

Radio 10-15

Proximity Warning 2-10

R

Radio

Changing the channel 3-7, 3-8

Changing the radio mode 3-6

Deleting a channel 3-10

Scanning channels 3-9

Rear-seat climate control function 2-18

Rear-seat conversation mode 2-20

Rear-seat quiet mode 2-21

Rear view screen 2-9

Recent calls list 6-7

S

Save searched place 5-22

Saving frequently visited places 5-24

Saving the current position 5-23

Settings

Advanced settings 9-49

Bluelink settings 9-81, 9-82

Bluetooth settings 9-47

Button settings 9-53, 9-54

Device connections settings 9-40, 9-44

Display settings 9-99, 9-104

General settings 9-86, 9-92

Media settings 9-109

Navigation settings 9-69, 9-74

Screen theme/layout settings 9-98

Sound settings 9-58, 9-62

User profile settings 9-83, 9-84

Vehicle settings 9-3, 9-20

Voice recognition settings 9-67, 9-68

Siri Eyes Free 7-21

SiriusXM 3-13

Changing to SiriusXM mode 3-13, 3-14

Featured Favorites channels 3-19, 3-20

Searching for channels 3-16

Selecting channels 3-18

Viewing the program schedule 3-18,
3-19

Software update 9-110

Solutions

Bluetooth connection 10-5

Navigation system operation 10-8

Phone projection 10-6

Sound and display 10-2

System operation 10-7

USB playback 10-4

- Sounds of Nature 2-22
- Split screen 1-16
- Steering wheel remote control 1-4
- Surround view monitor
 - Door opening/mirror folding alert 2-12
 - Rear view video 2-13
- System Info 9-87, 9-92
- System status indicator icons 10-9
- System update 9-110

T

- Touch screen 1-8
- Turning on/off the system 1-6

U

- Update 9-110
- USB file specifications 10-13
- USB music 4-2
- USB port 4-2
- USB storage device specifications 10-14

V

- Valet mode 2-28
- Voice memo 7-22
- Voice recognition
 - Help 7-4
 - POI name 7-11
 - Settings 9-67, 9-68
 - Using the voice recognition 7-3
 - Volume setting 7-4

Trademarks

- The Bluetooth® word mark and logos are registered trademarks owned by Bluetooth SIG, Inc. and any use of such marks by HYUNDAI is under license.



A Bluetooth® Wireless Technology enabled cell phone is required to use Bluetooth® Wireless Technology.

- Google, Android, Android Auto, and Google Play are registered trademarks of Google LLC. Distracted driving can result in a loss of vehicle control. Never use a handheld device or vehicle system that takes your focus away from safe vehicle operation.
- Apple®, Apple CarPlay™, iPad®, iPad mini™, iPhone®, iPod®, iPod classic®, iPod nano®, iPod touch®, iTunes®, and Siri® are trademarks of Apple Inc. Distracted driving can result in a loss of vehicle control. Never use a handheld device or vehicle system that takes your focus away from safe vehicle operation.

- HD Radio™ Technology is manufactured under license from iBiquity Digital Corporation. U.S. and Foreign Patents. For patents, see <https://dts.com/patents/>. HD Radio and the HD, HD Radio™, and "ARC" logos are registered trademarks or trademarks of iBiquity Digital Corporation in the United States and/or other countries.



- Sirius, XM, SiriusXM and all related marks and logos are trademarks of SiriusXM Radio Inc.
- Other trademarks and trade names are those of their respective owners.

Open Source Information

This system contains open source software.

To obtain the source code developed under the open source license installed on this product, please visit <https://en.mobis.co.kr/opensource/list.do>.

You can download all applicable license notices, including the source code.

If you send an e-mail to MOBIS_OSSrequest@mobis.co.kr within three years of purchasing this product to request an open source code for the software on this product, you will receive it in CD-ROM and other storage mediums with minimal charge, such as costs for medium and transportation.

BK6
(English I CAN) GEN5Wide



S2MS6-BK003